

PSI-FLOOR DIAGRAMS AND A CAPORASO-HARRIS TYPE RECURSION

FLORIAN BLOCK, ANDREAS GATHMANN, AND HANNAH MARKWIG

ABSTRACT. Floor diagrams are combinatorial objects which organize the count of tropical plane curves satisfying point conditions. In this paper we introduce Psi-floor diagrams which count tropical curves satisfying not only point conditions but also conditions given by Psi-classes (together with points). We then generalize our definition to relative Psi-floor diagrams and prove a Caporaso-Harris type formula for the corresponding numbers. This formula is shown to coincide with the classical Caporaso-Harris formula for relative plane descendant Gromov-Witten invariants. As a consequence, we can conclude that in our case relative descendant Gromov-Witten invariants equal their tropical counterparts.

1. INTRODUCTION

On the moduli spaces $\overline{M}_{g,r}$ and $\overline{M}_{g,r}(\mathbb{P}^s, d)$ of r -marked genus- g stable curves (resp. stable maps of degree d to projective space \mathbb{P}^s), the *Psi-class* ψ_i for $i = 1, \dots, r$ is the first Chern class of the line bundle whose fiber over a point (C, x_1, \dots, x_r) (resp. (C, x_1, \dots, x_r, f)) is the cotangent space of C at x_i . These Psi-classes are useful to count curves with tangency conditions, for example. To count curves that satisfy incidence conditions (e.g. pass through given points), one defines evaluation maps on the space of stable maps, $\text{ev}_i : \overline{M}_{g,r}(\mathbb{P}^s, d) \rightarrow \mathbb{P}^s$, which send a stable map (C, x_1, \dots, x_r, f) to the image $f(x_i)$ of the marked point x_i . Then we can pull back the incidence conditions via the evaluation maps. Finally, we can intersect pullbacks along the evaluation maps and Psi-classes on $\overline{M}_{g,r}(\mathbb{P}^s, d)$. The degrees of such zero-dimensional intersection products are called *descendant Gromov-Witten invariants*. They have been studied in detail in Gromov-Witten theory.

Tropical geometry has been applied to enumerative problems very successfully. Grigory Mikhalkin has pioneered the field in [Mik05], proving the Correspondence Theorem for the numbers $N(d, g)$ of degree- d genus- g nodal plane curves through $3d + g - 1$ points in general position: counting such curves in algebraic geometry and in tropical geometry will give the same results. He also developed the tropical *lattice path algorithm* to determine these numbers. Tropical analogues of moduli spaces of stable curves and maps have been introduced in [Mik07, GKM09], and tropical intersection theory was used to define tropical enumerative numbers for rational curves analogously to the classical world. Andreas Gathmann and Hannah Markwig showed

Key words and phrases. Tropical geometry, enumerative geometry, Gromov-Witten theory.
2010 Mathematics Subject Classification: 14T05, 14N35, 51M20.

that the famous recursion formulas for the count of plane curves known as *Kontsevich's formula* [GM08] resp. *the Caporaso-Harris algorithm* [GM07] also hold in the tropical world and can be proven using purely tropical methods. Tropical analogues of Psi-classes on the space of abstract tropical curves $\mathcal{M}_{0,r}$ have been introduced by Grigory Mikhalkin [Mik07], and tropical descendant Gromov-Witten invariants on $\mathcal{M}_{0,r}(\mathbb{R}^2, d)$ by Hannah Markwig and Johannes Rau [MR09]. Markwig and Rau show that these tropical descendant Gromov-Witten invariants for which every Psi-condition ψ_i comes together with a point condition $\text{ev}_i^* \text{pt}$ satisfy the so-called *WDVV equations* which can be thought of as generalizations of Kontsevich's formula. It follows that those numbers are equal to their classical counterparts, i.e. a correspondence theorem holds here as well (proved indirectly). Tropical curves contributing to the count of such descendant Gromov-Witten invariants have higher-valent vertices at the marked points satisfying the Psi-conditions. Markwig and Rau also generalized the lattice path algorithm to count tropical descendant Gromov-Witten invariants.

Tropical descendant Gromov-Witten invariants play an important role in a recent work of Mark Gross [Gro09]: he proves a correspondence theorem for certain tropical descendant invariants and period integrals on the mirror of \mathbb{P}^2 . The philosophy of his paper is that mirror symmetry (or, more precisely, the correspondence of Gromov-Witten invariants and period integrals on the mirror) should follow easily from tropical geometry by proving correspondence theorems for tropical Gromov-Witten invariants and classical Gromov-Witten invariants on the one hand, and correspondence theorems for tropical Gromov-Witten invariants and period integrals on the other hand.

The Caporaso-Harris algorithm counts plane curves satisfying point conditions and multiplicity conditions to a fixed line, resulting in the so-called *relative Gromov-Witten invariants* of the plane. The rough idea of the algorithm is to move one of the points from its general position to the line. After this, the points are no longer in general position, and the curves satisfying the conditions might split into several components. One then collects the contributions from all the components and thus produces recursive relations. An analogue of the Caporaso-Harris algorithm for rational descendant Gromov-Witten invariants has been developed by Andreas Gathmann [Gat02].

To apply the same strategy in tropical geometry, we choose the infinitely far left vertical line. Tropical curves with higher multiplicities to this line are then just curves with *thick ends*, i.e. ends of higher weight in direction $(-1, 0)$. Instead of moving a point to the line, we just move the point far away to the left. The new point configuration is still in tropically general position, and the curves satisfying the conditions do not split into several components. However, if the far left point is not on an end, the tropical curve contains a part on the far left called a *floor* with one end in direction $(0, -1)$ and one end in direction $(1, 1)$, and this part is connected to the rest of the curve by horizontal edges only. The Caporaso-Harris recursion also holds for lattice paths [GM07].

By applying the Caporaso-Harris algorithm in tropical geometry several times (i.e. spreading the points p_1, \dots, p_r such that p_{i+1} is far left of p_i for all i) we can decompose the tropical curve into floors. The data of a tropical curve satisfying these point conditions can then be compressed into a *floor diagram* as introduced by Erwan Brugallé and Grigory Mikhalkin [BM07, BM09] and studied further by Sergey Fomin and Grigory Mikhalkin [FM10]. They also introduced floor diagrams to count relative plane Gromov-Witten invariants. Using floor diagrams, Fomin and Mikhalkin have been able to prove new results about node polynomials, and Florian Block computed node polynomials for curves with up to 14 nodes [Blo10]. Floor diagrams have also been applied to deduce recursive formulas of Caporaso-Harris type for Welschinger invariants [ABLdM08].

The aim of this paper is to introduce floor diagrams for plane descendant Gromov-Witten invariants (such that every Psi-condition ψ_i comes together with a point condition $\text{ev}_i^* \text{pt}$) which we call *Psi-floor diagrams*. The count of these diagrams gives exactly the tropical descendant Gromov-Witten invariants. Because of the Correspondence Theorem it then follows that they also give the classical descendant Gromov-Witten invariants. We generalize our definition to relative Psi-floor diagrams and prove that their count computes tropical relative Gromov-Witten invariants. Afterwards, we show that the numbers of relative Psi-floor diagrams satisfy a Caporaso-Harris formula and we show that our formula coincides with the classical formula by Gathmann mentioned above. It follows that relative Psi-floor diagrams (and thus also tropical relative descendant Gromov-Witten invariants) count relative descendant Gromov-Witten invariants.

The difficulty in generalizing the definition of floor diagrams to tropical curves satisfying Psi-conditions is that, because of the higher-valent vertices, we cannot necessarily split the curve into single floors. So we have to introduce multiple floors which are harder to deal with combinatorially. As a consequence, there is no longer a bijection between labeled floor diagrams and tropical curves. Rather, there are several tropical curves encoded in one Psi-floor diagram since there are many ways how a multiple floor can look in a tropical curve. Thus, we have to introduce new multiplicities for Psi-floor diagrams that encode how many tropical curves correspond to one diagram.

One can think of tropical geometry as a degeneration of classical geometry, and it is remarkable that enumerative numbers survive this degeneration. By passing from tropical curves to floor diagrams, we degenerate even further keeping only the combinatorial essence of the tropical curve count. Still, this data is enough to recover the Caporaso-Harris formula. We hope that Psi-floor diagrams will be useful in the future to prove new results about plane descendant Gromov-Witten invariants.

This paper is organized as follows: in Section 2 we recall the algebro-geometric definition of absolute and relative descendant Gromov-Witten invariants and the Caporaso-Harris formula for relative descendant Gromov-Witten invariants. Correspondingly, we then recall the definition of tropical descendant Gromov-Witten invariants and their equality to the corresponding classical numbers in Section 3.

We also generalize this definition to tropical relative descendant Gromov-Witten invariants. In Section 4 we introduce Psi-floor diagrams and their relative analogues and prove that they count the corresponding tropical curves. We prove that Psi-floor diagrams satisfy the same Caporaso-Harris formula as the corresponding relative descendant Gromov-Witten invariants. It follows that relative Psi-floor diagrams (and thus, tropical relative descendant Gromov-Witten invariants) count relative descendant Gromov-Witten invariants.

Part of this work was accomplished at the Mathematical Sciences Research Institute (MSRI) in Berkeley, CA, USA, during the one-semester program on tropical geometry. The authors would like to thank the MSRI for hospitality. In addition, Florian Block was supported by the NSF grant DMS-055588, Andreas Gathmann by the Simons Professorship of the MSRI, and Hannah Markwig by the MSRI and the German Research Foundation (Deutsche Forschungsgemeinschaft) through the Institutional Strategy of the University of Göttingen.

2. DESCENDANT GROMOV-WITTEN INVARIANTS

Let us start by recalling the algebro-geometric construction and computation of the absolute and relative descendant Gromov-Witten invariants whose corresponding tropical version we will study later in this paper. For details in this section we refer mainly to [FP97, KM98] in the absolute and [Gat02] in the relative case. Throughout this section we will work with the ground field \mathbb{C} of the complex numbers and denote by $A_*(X)$ and $A^*(X)$ the Chow homology and cohomology groups of a scheme (or stack) X . A class $\gamma \in A^i(X)$ will be said to have codimension $\text{codim } \gamma = i$, and the class of a hyperplane in a projective space \mathbb{P}^s will be denoted $h \in A^1(\mathbb{P}^s)$.

2.1. Absolute descendant Gromov-Witten invariants. For $s > 0$ and $r, d \geq 0$ we denote by $\bar{M}_{0,r}(\mathbb{P}^s, d)$ the moduli space of r -marked rational stable maps of degree d to the projective space \mathbb{P}^s (see [FP97] Section 4). Its points correspond to tuples (C, x_1, \dots, x_r, f) (modulo automorphisms) such that

- C is a connected, complete rational curve with at most nodes as singularities;
- x_1, \dots, x_r are distinct smooth points on C ;
- $f : C \rightarrow \mathbb{P}^s$ is a morphism of degree d , i.e. such that $f_*[C]$ is the class of d times a line; and
- the tuple (C, x_1, \dots, x_r, f) has only finitely many automorphisms.

Intuitively, $\bar{M}_{0,r}(\mathbb{P}^s, d)$ can be thought of as a compactification of the space of all rational degree- d curves in \mathbb{P}^s with r marked points. It is a smooth, complete, and separated stack of dimension $(s+1)d + s - 3 + r$.

For $i = 1, \dots, r$ there are so-called evaluation maps $\text{ev}_i : \bar{M}_{0,r}(\mathbb{P}^s, d) \rightarrow \mathbb{P}^s$ that send a tuple (C, x_1, \dots, x_r, f) to the image $f(x_i)$ of the i -th marked point. Moreover,

we denote by $\psi_i \in A^1(\bar{M}_{0,r}(\mathbb{P}^s, d))$ the i -th cotangent line class (also called the i -th Psi-class), i.e. the first Chern class of the line bundle whose fiber over a point (C, x_1, \dots, x_r, f) is the cotangent space of C at the (smooth) point x_i .

In general, descendant Gromov-Witten invariants are now defined by taking degrees of zero-dimensional intersection products of Psi-classes and pull-backs by the evaluation maps on the above moduli spaces. More precisely, pick $a_1, \dots, a_r \geq 0$ and $\gamma_1, \dots, \gamma_r \in A^*(\mathbb{P}^s)$ such that the dimension condition

$$\sum_{i=1}^r (a_i + \text{codim } \gamma_i) = \dim \bar{M}_{0,r}(\mathbb{P}^s, d)$$

holds. Then we define the corresponding Gromov-Witten invariant

$$\langle \tau^{a_1}(\gamma_1) \cdots \tau^{a_r}(\gamma_r) \rangle_d^{\mathbb{P}^s} := \deg \left(\text{ev}_1^* \gamma_1 \cdot \psi_1^{a_1} \cdot \cdots \cdot \text{ev}_r^* \gamma_r \cdot \psi_r^{a_r} \cdot [\bar{M}_{0,r}(\mathbb{P}^s, d)] \right) \in \mathbb{Q}.$$

For $a_1 = \cdots = a_r = 0$ we can simply think of this invariant as the number of rational degree- d curves in \mathbb{P}^s passing through r given generic subvarieties of classes $\gamma_1, \dots, \gamma_r$. For other choices of a_1, \dots, a_r these numbers do not have an immediate geometric interpretation, but they occur e.g. in the computation of numbers of curves satisfying tangency conditions in addition to incidence conditions.

The Gromov-Witten invariants above are all well-known; they can be computed e.g. using the WDVV and topological recursion relations (see [KM94] Section 3, [KM98] Corollary 1.3). In what follows we will need in particular the following invariants of \mathbb{P}^1 .

Lemma 2.1. *For all $a, b, c, d \geq 0$ with $a = 2d - 2 + b$ we have*

$$\langle \underbrace{1 \cdots 1}_b \underbrace{h \cdots h}_c \tau^a(h) \rangle_d^{\mathbb{P}^1} = \frac{d^c}{d!^2}.$$

Proof. The equation $a = 2d - 2 + b$ is simply the dimension condition. Let us first assume that $d > 0$. By the fundamental class and divisor axioms of Gromov-Witten invariants (see e.g. [Get98] Proposition 12) we then know that

$$\langle \underbrace{1 \cdots 1}_b \underbrace{h \cdots h}_c \tau^a(h) \rangle_d^{\mathbb{P}^1} = d^c \cdot \langle \tau^{a-b}(h) \rangle_d^{\mathbb{P}^1}.$$

As the one-point invariant $\langle \tau^a(h) \rangle_d^{\mathbb{P}^1}$ is equal to $\frac{1}{d!^2}$ by [Pan98] Section 1.4, the result follows.

In the special case $d = 0$ we see first of all that we must have $b \geq 2$ by the dimension condition. Thus we can again use the fundamental class and divisor axioms to reduce the invariant to

$$\langle \underbrace{1 \cdots 1}_b \underbrace{h \cdots h}_c \tau^a(h) \rangle_d^{\mathbb{P}^1} = d^c \cdot \langle 1 \ 1 \ \tau^0(h) \rangle_d^{\mathbb{P}^1} = d^c$$

as stated in the lemma (i.e. to 1 for $c = 0$ and to 0 otherwise). \square

Our main concern in this paper, however, will be the Gromov-Witten invariants of the projective plane \mathbb{P}^2 where each of the classes $\gamma_1, \dots, \gamma_r$ above is the class $\text{pt} = h^2$ of a point. By the dimension condition we then need non-negative integers a_1, \dots, a_r such that

$$2r + a_1 + \dots + a_r = \dim \bar{M}_{0,r}(\mathbb{P}^2, d), \quad \text{i.e. } a_1 + \dots + a_r = 3d - 1 - r$$

to get a well-defined number $\langle \tau^{a_1}(\text{pt}) \cdots \tau^{a_r}(\text{pt}) \rangle_d^{\mathbb{P}^2}$. Note that by the symmetry of the points this number depends only on how often each Psi-power occurs among the numbers a_1, \dots, a_r . Let us therefore introduce a simplified notation that reflects this symmetry and that will be particularly useful when considering floor diagrams later:

Notation 2.2 (Sequences). *Let $\mathbf{k} = (\mathbf{k}_0, \mathbf{k}_1, \mathbf{k}_2, \dots)$ be a sequence of non-negative integers with only finitely many non-zero entries. We set*

$$\begin{aligned} |\mathbf{k}| &:= \mathbf{k}_0 + \mathbf{k}_1 + \mathbf{k}_2 + \dots, \\ I\mathbf{k} &:= 0\mathbf{k}_0 + 1\mathbf{k}_1 + 2\mathbf{k}_2 + \dots, \\ I^{\mathbf{k}} &:= 0^{\mathbf{k}_0} \cdot 1^{\mathbf{k}_1} \cdot 2^{\mathbf{k}_2} \cdot \dots, \\ \mathbf{k}! &:= \mathbf{k}_0! \cdot \mathbf{k}_1! \cdot \mathbf{k}_2! \cdot \dots \end{aligned}$$

Moreover, if \mathbf{k}, \mathbf{k}' are two such sequences we define the sequence $\mathbf{k} + \mathbf{k}'$ by componentwise addition and write $\mathbf{k} \leq \mathbf{k}'$ if $\mathbf{k}_i \leq \mathbf{k}'_i$ for all $i \geq 0$. To simplify notation, we will usually write such sequences as finite sequences $(\mathbf{k}_0, \dots, \mathbf{k}_n)$ for some n with the convention that the remaining entries $\mathbf{k}_{n+1}, \mathbf{k}_{n+2}, \dots$ are then equal to zero.

Definition 2.3 ($\tilde{N}_{d,\mathbf{k}}$ and $N_{d,\mathbf{k}}$). Let $d \geq 0$, and let $\mathbf{k} = (\mathbf{k}_0, \mathbf{k}_1, \mathbf{k}_2, \dots)$ be a sequence of non-negative integers such that $I\mathbf{k} = 3d - 1 - |\mathbf{k}|$. For $r = |\mathbf{k}|$ let a_1, \dots, a_r be an r -tuple of non-negative integers that contains each number $i \in \mathbb{N}$ exactly \mathbf{k}_i times (in any order). We then define

$$\tilde{N}_{d,\mathbf{k}} := \langle \tau^{a_1}(\text{pt}) \cdots \tau^{a_r}(\text{pt}) \rangle_d^{\mathbb{P}^2} \quad \text{and} \quad N_{d,\mathbf{k}} := \frac{|\mathbf{k}|!}{\mathbf{k}!} \tilde{N}_{d,\mathbf{k}}.$$

Remark 2.4. The two sets of numbers $\tilde{N}_{d,\mathbf{k}}$ and $N_{d,\mathbf{k}}$ count the following: the $\tilde{N}_{d,\mathbf{k}}$ are the numbers of rational plane degree- d curves passing through r points and satisfying in addition a ψ^i condition at \mathbf{k}_i chosen marked points for all i . If we do not choose the points for the ψ^i conditions but rather only require that among the r marked points there are \mathbf{k}_i of them at which a ψ^i condition is satisfied (i.e. sum over all tuples a_1, \dots, a_r above containing each i exactly \mathbf{k}_i times) then we get instead the numbers $N_{d,\mathbf{k}}$, which will turn out to be more natural when considering floor diagrams later.

2.2. Relative descendant Gromov-Witten invariants. Relative invariants are very similar to the absolute invariants of Section 2.1, except that we now fix once and for all a line $H \subset \mathbb{P}^2$ and count curves in \mathbb{P}^2 that have prescribed local intersection multiplicities with H in addition to satisfying the evaluation and Psi-conditions above.

More precisely, choose $d > 0$ and let $\mu_1, \dots, \mu_r \in \mathbb{N}$ for some $r > 0$ such that $\mu_1 + \dots + \mu_r = d$. Setting $\boldsymbol{\mu} = (\mu_1, \dots, \mu_r)$, we denote by $\bar{M}_{0,\boldsymbol{\mu}}(\mathbb{P}^2, d) \subset \bar{M}_{0,r}(\mathbb{P}^2, d)$ the closure of the subset of all (C, x_1, \dots, x_r, f) such that C is smooth and $f^*H = \mu_1 x_1 + \dots + \mu_r x_r$ as divisors on C (see [Gat02] Section 1). These spaces are called the moduli spaces of stable maps relative to H ; they have dimension $2d - 1 + r$.

As in the absolute case, degrees of zero-dimensional intersection products of Psi-classes and pull-backs by the evaluation maps on the moduli spaces of relative stable maps are called relative descendant Gromov-Witten invariants. So if we now fix $a_1, \dots, a_r \in \mathbb{N}$ and $\gamma_1, \dots, \gamma_r \in A^*(\mathbb{P}^2)$ such that

$$\sum_{i=1}^r (a_i + \text{codim } \gamma_i) = \dim \bar{M}_{0,\boldsymbol{\mu}}(\mathbb{P}^2, d),$$

we can define in a similar way as above an associated relative Gromov-Witten invariant

$$\langle \tau^{a_1}(\gamma_1) \cdots \tau^{a_r}(\gamma_r) \rangle_{\boldsymbol{\mu}}^{\mathbb{P}^2} := \deg(\text{ev}_1^* \gamma_1 \cdot \psi_1^{a_1} \cdots \text{ev}_r^* \gamma_r \cdot \psi_r^{a_r} \cdot [\bar{M}_{0,\boldsymbol{\mu}}(\mathbb{P}^2, d)]) \in \mathbb{Q}.$$

If $a_1 = \dots = a_r = 0$ this invariant can be interpreted by construction as the number of plane rational degree- d curves with r marked points that have local intersection multiplicity μ_i and, in addition, pass through a generic subvariety of \mathbb{P}^2 of class γ_i at the i -th marked point, for all $i = 1, \dots, r$. In particular, the marked points x_i with $\mu_i > 0$ will lie on H , whereas the ones with $\mu_i = 0$ in general do not.

As before, we will restrict our attention in this paper to a certain subset of these invariants. Namely, we will only consider choices of $\mu_1, \dots, \mu_r, a_1, \dots, a_r, \gamma_1, \dots, \gamma_r$ corresponding to Psi-conditions only at points away from H , i.e. such that for all $i = 1, \dots, r$ we have one of the following cases:

- $\mu_i > 0$, $a_i = 0$, and $\gamma_i = h^1$ the class of a line (i.e. a marked point lying on a fixed point of H with a given local intersection multiplicity of the curve to H). For $j \geq 1$ we will denote the number of such i with $\mu_i = j$ by α_j .
- $\mu_i > 0$, $a_i = 0$, and $\gamma_i = h^0$ (i.e. a marked point lying on a non-fixed point of H with a given local intersection multiplicity of the curve to H). For $j \geq 1$ we will denote the number of such i with $\mu_i = j$ by β_j .
- $\mu_i = 0$ and $\gamma_i = h^2$ (i.e. a marked point lying on a fixed generic point of \mathbb{P}^2 and possibly satisfying some Psi-conditions). For $j \geq 0$ we will denote the number of such i with $a_i = j$ by \mathbf{k}_j .

By symmetry of the marked points, the three sequences $\alpha = (\alpha_1, \alpha_2, \dots)$, $\beta = (\beta_1, \beta_2, \dots)$, and $\mathbf{k} = (\mathbf{k}_0, \mathbf{k}_1, \mathbf{k}_2, \dots)$ determine the invariant under consideration uniquely. So we can make the following definition:

Definition 2.5 ($\tilde{N}_{d,\mathbf{k}}(\alpha, \beta)$ and $N_{d,\mathbf{k}}(\alpha, \beta)$). With notations as above, we set

$$\tilde{N}_{d,\mathbf{k}}(\alpha, \beta) := \langle \tau^{a_1}(\gamma_1) \cdots \tau^{a_r}(\gamma_r) \rangle_{\boldsymbol{\mu}}^{\mathbb{P}^2}.$$

So $\tilde{N}_{d,\mathbf{k}}(\alpha, \beta)$ is the number of plane rational marked degree- d curves (C, x_1, \dots, x_r, f) satisfying the following conditions:

- For each $i \in \mathbb{N}$ fix α_i of the marked points on C and a general point on H for each of them; each of these marked points then has to be mapped by f to the corresponding given point on H , and C must have local intersection multiplicity i to H there.
- For each $i \in \mathbb{N}$ fix β_i of the marked points on C ; each of these marked points then has to be mapped by f to H , and C must have local intersection multiplicity i to H there.
- For each $i \in \mathbb{N}$ fix \mathbf{k}_i of the marked points on C and a general point in \mathbb{P}^2 for each of them; each of these marked points then has to be mapped by f to the corresponding given point in \mathbb{P}^2 , and C must satisfy in addition a ψ^i condition there.

Note that the dimension condition translates to

$$I(\alpha + \beta + \mathbf{k}) = 3d - 1 + |\beta| - |\mathbf{k}|$$

in these variables, where we use notation 2.2 also for the sequences α and β (although they start at index 1 rather than 0). In the same way, the condition $\mu_1 + \dots + \mu_r = d$ translates to

$$I(\alpha + \beta) = d.$$

As in Definition 2.3 let us also introduce a slight variant of these invariants where we do not specify which Psi-power condition has to be satisfied at which point x_i with $\mu_i = 0$, and where we do not mark the non-fixed points on H of the curves: we set

$$N_{d,\mathbf{k}}(\alpha, \beta) := \frac{1}{\beta!} \cdot \frac{|\mathbf{k}|!}{\mathbf{k}!} \cdot \tilde{N}_{d,\mathbf{k}}(\alpha, \beta).$$

Just like their absolute counterparts all relative Gromov-Witten invariants that we have introduced in this section are actually known to be computable recursively. To do so one uses a generalization of the Caporaso-Harris formula of [CH98] that we will describe now.

2.3. The Caporaso-Harris formula for descendant invariants. In this section we want to use relative Gromov-Witten theory to derive a recursive formula for the numbers $\tilde{N}_{d,\mathbf{k}}(\alpha, \beta)$ (and thus also for $N_{d,\mathbf{k}}(\alpha, \beta)$) of Definition 2.5.

As in the beginning of Section 2.2 let $r, d > 0$ and $\mu_1, \dots, \mu_r \geq 0$ with $\mu_1 + \dots + \mu_r = d$. We have then constructed a moduli space $\bar{M}_{0,\mu}(\mathbb{P}^2, d) \subset \bar{M}_{0,r}(\mathbb{P}^2, d)$ of dimension $2d - 1 + r$ of plane rational degree- d stable maps relative to a fixed line $H \subset \mathbb{P}^2$, and our invariants $\tilde{N}_{d,\mathbf{k}}(\alpha, \beta)$ were certain zero-dimensional intersection products on these spaces.

Since $\mu_1 + \dots + \mu_r = d$ there can be at most d marked points x_i with $\mu_i > 0$. Note that our invariants had no Psi-conditions and at most a codimension-1 evaluation condition at all these points. So the conditions at these marked points yield a cycle of codimension at most d — and as the dimension of our moduli space is $2d - 1 + r > d$ it follows that there must be at least one marked point x_i with $\mu_i = 0$. By symmetry

we may assume without loss of generality that x_1 is such a marked point, i.e. that $\mu_1 = 0$. For our invariant this marked point x_1 is then required to map to a given general point in \mathbb{P}^2 .

The idea of the proof is now to move this generic chosen point to a special position, namely to a point on H . As we have marked all intersection points of the curves with H already (note that $\mu_1 + \dots + \mu_r = d$) this forces the curves to become reducible and split up into several components of smaller degree, one of which will be mapped completely to H . The curves can then be enumerated recursively over the degree.

To describe this process more formally we follow the notation and results from Section 2 of [Gat02]. Note, however, that our current situation is a little simplified compared to [Gat02] since we have assumed here that $\mu_1 + \dots + \mu_r = d$.

Construction 2.6 (Moduli spaces $D(A, B)$, see Definition 2.2 of [Gat02]). Fix $r, d > 0$ and a moduli space $\bar{M}_{0, \boldsymbol{\mu}}(\mathbb{P}^2, d) \subset \bar{M}_{0, r}(\mathbb{P}^2, d)$ with $\boldsymbol{\mu} = (\mu_1, \dots, \mu_r)$ and $\mu_1 + \dots + \mu_r = d$ as above.

Choose a partition $A = (A', A^1, \dots, A^t)$ of $\{1, \dots, r\}$ for some $t \geq 0$, and let $\boldsymbol{\mu}^i$ for $i = 1, \dots, t$ be the tuple of all μ_j with $j \in A^i$ (in any order). Moreover, pick a $(t+1)$ -tuple $B = (d', d^1, \dots, d^t)$ of non-negative integers with $d^i > 0$ for $i = 1, \dots, t$ and $d' + d^1 + \dots + d^t = d$. We assume that we have made our choices so that

$$(2.1) \quad m^i := d^i - \sum_{j \in A^i} \mu_j > 0$$

for all $i = 1, \dots, t$, and thus (by adding all these equations up and comparing the sum to $\mu_1 + \dots + \mu_r = d$) so that

$$(2.2) \quad d' + m^1 + \dots + m^t = \sum_{j \in A'} \mu_j.$$

In this case we now define the space $D(A, B)$ to be

$$D(A, B) := \bar{M}_{0, t + \#A'}(H, d') \times_{(\mathbb{P}^1)^t} \prod_{i=1}^t \bar{M}_{0, (m^i) \cup \boldsymbol{\mu}^i}(\mathbb{P}^2, d^i),$$

where $(m^i) \cup \boldsymbol{\mu}^i$ denotes the $(\#A^i + 1)$ -tuple obtained by prepending m^i at the beginning of $\boldsymbol{\mu}^i$, and the maps to $(\mathbb{P}^1)^t$ for the fiber product are the evaluation at the first t marked points of the first factor and at the first marked point of each of the moduli spaces in the second factor. Note that the first factor is a moduli space of absolute stable maps to the line $H \cong \mathbb{P}^1$, whereas the second factor consists of moduli spaces of stable maps to \mathbb{P}^2 relative to H .

By construction, $D(A, B)$ parameterizes stable maps to \mathbb{P}^2 with (generically) $t+1$ irreducible components: one “central” component in H , and t “external” components in \mathbb{P}^2 all attached to the central one at a point where they have a local intersection multiplicity to H as given by m^1, \dots, m^t . The $(t+1)$ -tuples A and B simply parameterize how the marked points and the degree split up onto the $t+1$ components. In this way $D(A, B)$ can be considered as a closed subspace of $\bar{M}_{0, r}(\mathbb{P}^2, d)$.

Note that the case $t = 0$ is allowed (i.e. there may be no external components at all), as well as $d' < 1$ and $d' > 1$ (i.e. the central component may be a contracted one or a multiple cover of H). The following picture shows an example of a general element $(C, x_1, \dots, x_5, f) \in D(A, B)$ for $d = 5$, $r = 3$, $\mu = (4, 0, 1)$, $A = (\{1\}, \emptyset, \{2, 3\})$, $B = (1, 2, 2)$, and thus $\mu^1 = ()$, $\mu^2 = (0, 1)$, $m^1 = 2$, and $m^2 = 1$.

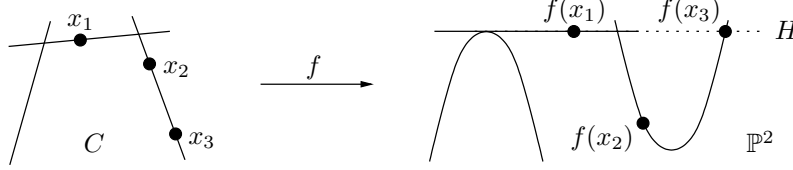

The importance of these moduli spaces comes from the fact that they describe precisely the curves appearing when moving a marked point from a general position in \mathbb{P}^2 to H . In fact, all $D(A, B)$ are divisors in $\bar{M}_{0,\mu}(\mathbb{P}^2, d)$, and we have the following statement:

Proposition 2.7 (Theorem 2.6 of [Gat02]). *With notations as above, we have*

$$\text{ev}_1^* H \cdot \bar{M}_{0,\mu}(\mathbb{P}^2, d) = \sum_{t,A,B} \frac{m^1 \cdot \dots \cdot m^t}{t!} D(A, B)$$

in the Chow group of $\bar{M}_{0,\mu}(\mathbb{P}^2, d)$, where the sum is taken over all $t \geq 0$, A , and B with $1 \in A'$ and satisfying condition (2.1) (and thus also (2.2)) as in Construction 2.6.

As usual in Gromov-Witten theory it is now convenient to replace the fiber product in the Construction 2.6 of $D(A, B)$ by the “diagonal splitting” trick: the fiber product $X \times_{\mathbb{P}^1} Y$ of two spaces X and Y with projections p and q to \mathbb{P}^1 can be rewritten as the pull-back of the diagonal of $\mathbb{P}^1 \times \mathbb{P}^1$ by the map $p \times q$, and as this diagonal has class $h \times 1 + 1 \times h$ it follows that

$$X \times_{\mathbb{P}^1} Y = (p^*h + q^*h) \cdot (X \times Y).$$

Let us apply this formula in the expression for $D(A, B)$ from Construction 2.6 for each of the t factors \mathbb{P}^1 over which we take the fiber product, thus converting $D(A, B)$ into a sum of 2^t terms with no fiber products. By symmetry, we can then always relabel the external t components so that the ones with the ev^*h term in the $\bar{M}_{0,(m^i) \cup \mu^i}(\mathbb{P}^2, d^i)$ factor come first — if there are $t' \in \{0, \dots, t\}$ of these components we then have $\binom{t}{t'}$ terms in the diagonal splitting that become the same after this relabeling. Hence we can rewrite the formula of Proposition 2.7 in the following form:

$$\begin{aligned} \text{ev}_1^* H \cdot \bar{M}_{0,\mu}(\mathbb{P}^2, d) &= \sum_{t,A,B} \sum_{t'=0}^t \frac{m^1 \cdot \dots \cdot m^t}{t!(t-t)!} \left(\text{ev}_{t'+1}^* h \cdot \dots \cdot \text{ev}_t^* h \cdot \bar{M}_{0,t+\#A'}(H, d') \right) \\ &\quad \times \prod_{i=1}^{t'} \left(\text{ev}_1^* h \cdot \bar{M}_{0,(m^i) \cup \mu^i}(\mathbb{P}^2, d^i) \right) \times \prod_{i=t'+1}^t \bar{M}_{0,(m^i) \cup \mu^i}(\mathbb{P}^2, d^i). \end{aligned}$$

To get a recursive relation for the invariants

$$\tilde{N}_{d,\mathbf{k}}(\alpha, \beta) = \langle \tau^{a_1}(\gamma_1) \cdots \tau^{a_r}(\gamma_r) \rangle_{\mu}^{\mathbb{P}^2}$$

of Definition 2.5 we now intersect this equation of cycles with the class

$$\mathrm{ev}_1^* h \cdot \psi_1^{a_1} \cdot \mathrm{ev}_2^* \gamma_2 \cdot \psi_2^{a_2} \cdot \cdots \cdot \mathrm{ev}_r^* \gamma_r \cdot \psi_r^{a_r}$$

(note that $\gamma_1 = \mathrm{pt}$ by assumption, and thus the two evaluations $\mathrm{ev}_1^* H \cdot \mathrm{ev}_1^* h$ together give the desired condition $\mathrm{ev}_1^* \gamma_1$ at the first point). The left hand side of the equation is then simply $\tilde{N}_{d,\mathbf{k}}(\alpha, \beta)$. Each summand on the right hand side is a product of one absolute Gromov-Witten invariant of \mathbb{P}^1 and t relative Gromov-Witten invariants of \mathbb{P}^2 . The invariant of \mathbb{P}^1 has the condition $\mathrm{ev}_1^* h \cdot \psi_1^{a_1}$ at the first marked point, a condition $\mathrm{ev}_i^* h$ at all gluing points from the last $t - t'$ external components and all x_i with $i \in A'$ such that $\gamma_i = h$, and no condition at all at the other points. On the other hand, the t relative invariants of \mathbb{P}^2 are again of the type of invariants considered in Definition 2.5: we can write them as $N_{d^i, \mathbf{k}^i}(\alpha^i + e_{m^i}, \beta^i)$ for the first t' and $N_{d^i, \mathbf{k}^i}(\alpha^i, \beta^i + e_{m^i})$ for the last $t - t'$ invariants, where $\alpha^i, \beta^i, \mathbf{k}^i$ denote the sequences associated to the marked points x_j with $j \in A^i$ according to Definition 2.5. Finally, let us then rewrite the sum over A as a sum over the corresponding sequences $\alpha^i, \beta^i, \mathbf{k}^i$. If we set

$$(2.3) \quad \alpha' := \alpha - \alpha^1 - \cdots - \alpha^t \quad \text{and} \quad \binom{\alpha}{\alpha^1, \dots, \alpha^t} := \prod_{i \geq 1} \frac{\alpha_i!}{\alpha_i^1! \cdots \alpha_i^t! \cdot \alpha_i'!}$$

(and similarly for β and \mathbf{k} , except that the index of the sequences starts at 0 for \mathbf{k}), then exactly

$$\binom{\alpha!}{\alpha^1, \dots, \alpha^t} \cdot \binom{\beta!}{\beta^1, \dots, \beta^t} \cdot \binom{\mathbf{k} - e_a}{\mathbf{k}^1, \dots, \mathbf{k}^t}$$

choices of partitions of A into t subsets will give rise to the same invariants. Here, e_a denotes the sequence with only non-zero entry 1 in the a -th component — we have to write $\mathbf{k} - e_a$ instead of \mathbf{k} since the first marked point is fixed to lie on the central component, so there is no choice here where to put this point. Hence our equation becomes

$$\begin{aligned} \tilde{N}_{d,\mathbf{k}}(\alpha, \beta) &= \sum_{t, t'} \sum_{\alpha, \beta, \mathbf{k}} \sum_B \frac{m^1 \cdots m^t}{t! (t - t')!} \binom{\alpha}{\alpha^1, \dots, \alpha^t} \binom{\beta}{\beta^1, \dots, \beta^t} \binom{\mathbf{k} - e_a}{\mathbf{k}^1, \dots, \mathbf{k}^t} \\ &\quad \cdot \underbrace{\langle 1 \cdots 1 \rangle_{|\beta'|+t'}}_{|\beta'|+t'} \underbrace{\langle h \cdots h \rangle_{|\alpha'|+t-t'}}_{|\alpha'|+t-t'} \tau^a(h) \rangle_{d'}^{\mathbb{P}^1} \\ &\quad \cdot \prod_{i=1}^{t'} N_{d^i, \mathbf{k}^i}(\alpha^i + e_{m^i}, \beta^i) \cdot \prod_{i=t'+1}^t N_{d^i, \mathbf{k}^i}(\alpha^i, \beta^i + e_{m^i}) \end{aligned}$$

Note that we must have $\mathbf{k}^1 + \cdots + \mathbf{k}^t = \mathbf{k} - e_a$ in each term since marked points with generic point conditions in \mathbb{P}^2 cannot lie in the central component within H . Moreover, each relative invariant in this expression must of course satisfy the dimension

condition

$$\begin{aligned} I((\alpha^i + e_{m^i}) + \beta^i + \mathbf{k}^i) &= 3d^i - 1 + |\beta^i| - |\mathbf{k}^i| && \text{for } i \leq t' \\ \text{resp. } I(\alpha^i + (\beta^i + e_{m^i}) + \mathbf{k}^i) &= 3d^i - 1 + |\beta^i + e_{m^i}| - |\mathbf{k}^i| && \text{for } i > t' \end{aligned}$$

of Definition 2.5, as well as condition (2.1)

$$m^i = d^i - I(\alpha^i + \beta^i)$$

of Construction 2.6. We can think of the first of these equations as determining d^i , and of the second as determining m^i from α^i , β^i , and \mathbf{k}^i . Finally, inserting the expression of Lemma 2.1 for the absolute Gromov-Witten invariant of \mathbb{P}^1 we get the following result that allows us to compute all numbers $\tilde{N}_{d,\mathbf{k}}(\alpha, \beta)$ recursively.

Theorem 2.8 (Caporaso-Harris formula for the relative descendant Gromov-Witten invariants $\tilde{N}_{d,\mathbf{k}}(\alpha, \beta)$). *The relative Gromov-Witten invariants $\tilde{N}_{d,\mathbf{k}}$ of Definition 2.5 satisfy the relations*

$$\begin{aligned} \tilde{N}_{d,\mathbf{k}}(\alpha, \beta) &= \sum \frac{m^1 \cdot \dots \cdot m^t}{t!(t-t')!} \cdot \frac{d^{|\alpha'|+t-t'}}{d'^{!2}} \binom{\alpha}{\alpha^1, \dots, \alpha^t} \binom{\beta}{\beta^1, \dots, \beta^t} \binom{\mathbf{k} - e_a}{\mathbf{k}^1, \dots, \mathbf{k}^t} \\ &\quad \cdot \prod_{i=1}^{t'} \tilde{N}_{d^i, \mathbf{k}^i}(\alpha^i + e_{m^i}, \beta^i) \cdot \prod_{i=t'+1}^t \tilde{N}_{d^i, \mathbf{k}^i}(\alpha^i, \beta^i + e_{m^i}) \end{aligned}$$

for each $a \in \mathbb{N}$ with $\mathbf{k}_a > 0$. Here, the sum is taken over all $0 \leq t' \leq t$ and all sequences $\alpha^1, \dots, \alpha^t, \beta^1, \dots, \beta^t, \mathbf{k}^1, \dots, \mathbf{k}^t$ such that

- $\alpha' := \alpha - \alpha^1 - \dots - \alpha^t \geq 0$, $\beta' := \beta - \beta^1 - \dots - \beta^t \geq 0$, and $\mathbf{k}^1 + \dots + \mathbf{k}^t = \mathbf{k} - e_a$;
- $d^i := \frac{1}{3}(I(\alpha^i + \beta^i + \mathbf{k}^i + e_{m^i}) - |\beta^i| + |\mathbf{k}^i| + 1) \in \mathbb{N}_{>0}$ for $i = 1, \dots, t'$, and $d^i := \frac{1}{3}(I(\alpha^i + \beta^i + \mathbf{k}^i + e_{m^i}) - |\beta^i| + |\mathbf{k}^i|) \in \mathbb{N}_{>0}$ for $i = t' + 1, \dots, t$;
- $d' := d - d_1 - \dots - d_t \geq 0$;
- $m^i := d^i - I(\alpha^i + \beta^i) > 0$ for all $i = 1, \dots, t$.

It is easy to rewrite this formula so that it computes the invariants $N_{d,\mathbf{k}}(\alpha, \beta)$ instead of $\tilde{N}_{d,\mathbf{k}}(\alpha, \beta)$:

Corollary 2.9 (Caporaso-Harris formula for the relative descendant Gromov-Witten invariants $N_{d,\mathbf{k}}(\alpha, \beta)$). *The invariants $N_{d,\mathbf{k}}(\alpha, \beta)$ of Definition 2.5 satisfy the relations*

$$\begin{aligned} N_{d,\mathbf{k}}(\alpha, \beta) &= \sum_{a: \mathbf{k}_a > 0} \sum \frac{m^1 \cdot \dots \cdot m^t}{t!(t-t')!} \cdot \frac{d^{|\alpha'|+t-t'}}{d'^{!2}} \binom{\alpha}{\alpha^1, \dots, \alpha^t} \frac{1}{\beta'^!} \binom{|\mathbf{k}| - 1}{|\mathbf{k}^1|, \dots, |\mathbf{k}^t|} \\ &\quad \cdot \prod_{i=1}^{t'} N_{d^i, \mathbf{k}^i}(\alpha^i + e_{m^i}, \beta^i) \cdot \prod_{i=t'+1}^t (\beta_{m^i}^i + 1) N_{d^i, \mathbf{k}^i}(\alpha^i, \beta^i + e_{m^i}) \end{aligned}$$

where the second sum is taken over the same partitions and with the same conditions as in Theorem 2.8.

Proof. Inserting the expression of Definition 2.5 for the numbers $N_{d,\mathbf{k}}(\alpha, \beta)$ in terms of $\tilde{N}_{d,\mathbf{k}}(\alpha, \beta)$ into the formula of Theorem 2.8 gives

$$N_{d,\mathbf{k}}(\alpha, \beta) = \sum \frac{m^1 \cdot \dots \cdot m^t}{t!(t-t)!} \cdot \frac{d^{|\alpha'|+t-t'}}{d'^2} \binom{\alpha}{\alpha^1, \dots, \alpha^t} \frac{1}{\beta'!} \binom{|\mathbf{k}|-1}{|\mathbf{k}^1|, \dots, |\mathbf{k}^t|} \frac{|\mathbf{k}|}{\mathbf{k}_a} \\ \cdot \prod_{i=1}^{t'} N_{d^i, \mathbf{k}^i}(\alpha^i + e_{m^i}, \beta^i) \cdot \prod_{i=t'+1}^t (\beta_{m^i}^i + 1) N_{d^i, \mathbf{k}^i}(\alpha^i, \beta^i + e_{m^i})$$

for all a with $\mathbf{k}_a > 0$. Multiplying these equations with $\frac{\mathbf{k}_a}{|\mathbf{k}|}$ and summing them up for all a then gives the desired equation since $\sum_a \frac{\mathbf{k}_a}{|\mathbf{k}|} = 1$. \square

3. TROPICAL DESCENDANT GROMOV-WITTEN INVARIANTS

In the last section we have introduced several algebro-geometric descendant rational Gromov-Witten invariants of the projective plane:

- the *absolute* invariants $\tilde{N}_{d,\mathbf{k}}$ and $N_{d,\mathbf{k}}$ counting degree- d curves through points and Psi-conditions as specified by \mathbf{k} (see Definition 2.3);
- the *relative* invariants $\tilde{N}_{d,\mathbf{k}}(\alpha, \beta)$ and $N_{d,\mathbf{k}}(\alpha, \beta)$ counting degree- d curves through points, Psi-conditions as specified by \mathbf{k} , and multiplicity conditions to a fixed line as specified by α and β (see Definition 2.5).

The convention here was that the numbers called \tilde{N} consider all points at which some condition has to be satisfied as marked points, whereas the numbers called N are obtained from these by a simple combinatorial factor dividing out some symmetries in the conditions.

We will now introduce corresponding numbers with a superscript “trop” (e.g. $\tilde{N}_{d,\mathbf{k}}^{\text{trop}}$) arising from the count of *tropical curves*, as well as — in the following Section 4 — numbers with a superscript “floor” (e.g. $\tilde{N}_{d,\mathbf{k}}^{\text{floor}}$) obtained by counting *floor diagrams*. The convention mentioned above will still hold for these numbers; we will see however that the N numbers seem to be more natural from the point of view of floor diagrams, whereas the \tilde{N} have been more natural in the algebro-geometric setting. In the end however, all corresponding numbers will turn out to be the same, e.g. $\tilde{N}_{d,\mathbf{k}} = \tilde{N}_{d,\mathbf{k}}^{\text{trop}} = \tilde{N}_{d,\mathbf{k}}^{\text{floor}}$ for all d and \mathbf{k} . In fact, this is the main result of this paper: that the (rational plane) absolute and relative descendant Gromov-Witten invariants of algebraic geometry can also be computed using certain counts of floor diagrams.

3.1. Absolute tropical descendant Gromov-Witten invariants. As mentioned in the introduction, tropical descendant Gromov-Witten invariants can be defined as intersection products on the tropical analogue of the moduli spaces of stable maps [MR09]. However, in order to avoid introducing too much notation, we choose to define them here purely in terms of the combinatorial properties of the tropical curves which we want to count.

A (*rational*) *abstract tropical curve* is a connected metric graph Γ of genus 0 (considered as a topological space, with the edges homeomorphic to closed real intervals), such that unbounded edges (with no vertex there) are allowed, and such that each vertex has valence at least 3 (see [GKM09] Definition 3.2). The unbounded edges will be called *ends*, and the length of a bounded edge e will be denoted $l(e) \in \mathbb{R}_{>0}$. We say that such a curve is an *n -marked abstract tropical curve* if n of the ends are marked by x_1, \dots, x_n . Two (marked) abstract tropical curves are isomorphic (and will from now on be identified) if there is an isometry between them (that respects x_1, \dots, x_n in the marked case).

We now want to consider maps from marked abstract tropical curves to \mathbb{R}^2 . For our later purposes it will be convenient to consider some of the *left ends* to be marked ends, whereas the other (non-contracted) ends will be unmarked.

Definition 3.1. Let $m \geq n \geq 0$. A (*parameterized plane*) *n -marked tropical curve* (with $m - n$ marked left ends) is a tuple $(\Gamma, x_1, \dots, x_m, h)$, where $(\Gamma, x_1, \dots, x_m)$ is an m -marked abstract tropical curve and $h : \Gamma \rightarrow \mathbb{R}^2$ is a continuous map satisfying the following conditions.

- On each edge e the map h is integer affine linear, i.e. of the form $h(t) = a + t \cdot v$ for $a \in \mathbb{R}^2$ and $v \in \mathbb{Z}^2$. If $V \in \partial e$ is a vertex of the edge e and we parameterize e starting at V , the vector v in the above equation will be denoted $v(V, e)$ and called the *direction vector* of e starting at V . If V is understood from the context (e.g. in case e is an end, having only one adjacent vertex) we will also write $v(e)$ instead of $v(V, e)$. The lattice length of $v(V, e)$ (i.e. the greatest common divisor of the entries of $v(V, e)$) will be called the *weight* $\omega(e)$ of e .
- At each vertex V the balancing condition

$$\sum_{e: V \in \partial e} v(V, e) = 0$$

is satisfied.

- Each marked end x_i for $i = 1, \dots, n$ is contracted by h (i.e. $v(x_i) = 0$).
- Each marked end x_i for $i = n + 1, \dots, m$ is a *left end* (i.e. it is of direction $(-l, 0)$ for some $l \in \mathbb{N}_{>0}$).

Two parameterized tropical curves are isomorphic if there is an isomorphism of the underlying marked abstract tropical curves commuting with h . Note that a parametrized n -marked curve will in general have more ends than the marked ones. The *degree* of such a curve is defined to be the multiset consisting of the directions of these non-marked ends, together with the directions of the marked left ends x_{n+1}, \dots, x_m . If the degree multiset consists of d copies of each of the vectors $(-1, 0)$, $(0, -1)$, and $(1, 1)$ we say that the curve is of *degree* d (see Example 3.4).

Definition 3.2 (Multiplicity of a curve). Let $C = (\Gamma, x_1, \dots, x_m, h)$ be a marked tropical curve of degree $\Delta = \{v_1, \dots, v_1, v_2, \dots, v_2, \dots, v_r, \dots, v_r\}$ (with v_1, \dots, v_r distinct) such that all vertices that are not adjacent to any of the contracted ends

x_1, \dots, x_n are 3-valent. Let V_1, \dots, V_t be the vertices of Γ . For $i = 1, \dots, t$ and $j = 1, \dots, r$ let b_{ij} the number of non-marked ends adjacent to V_i of direction v_j .

As in [Mik05] Definition 2.16 we define the multiplicity of a 3-valent vertex of C to be the absolute value of the determinant of two adjacent direction vectors. Setting $\nu_C := \prod_{i=1}^t \prod_{j=1}^r \frac{1}{b_{ij}}$, we then define the *multiplicity* $\text{mult}(C)$ of C to be ν_C times the product of the multiplicities of all vertices without adjacent contracted ends.

Definition 3.3 ($\tilde{N}_{d,\mathbf{k}}^{\text{trop}}$). Let $d \geq 1$, and let \mathbf{k} be a sequence of non-negative integers with $|\mathbf{k}| = 3d - 1 - |\mathbf{k}|$. Furthermore, for $n = |\mathbf{k}|$, fix a vector (a_1, \dots, a_n) that contains each number $i \in \mathbb{N}$ exactly \mathbf{k}_i times (in any order). Let $p_1, \dots, p_n \in \mathbb{R}^2$ be points in general position (see Definitions 3.2 and 9.7 of [MR09]). We define

$$\tilde{N}_{d,\mathbf{k}}^{\text{trop}} := \sum_C \text{mult}(C),$$

where the sum goes over all tropical curves $C = (\Gamma, x_1, \dots, x_n, h)$ (with non-marked left ends, i.e. $m - n = 0$) of degree d satisfying

- $h(x_i) = p_i$ for all $i = 1, \dots, n$, and
- the end x_i is adjacent to a vertex of valence $a_i + 3$ for all $i = 1, \dots, n$.

It follows from the general position of the points that all other vertices of Γ are then 3-valent.

Example 3.4. The following picture shows a parameterized 9-marked tropical curve. We have drawn the contracted marked ends as dotted lines. We did not specify the lengths of the bounded edges in the abstract curve since they are determined by the lengths of the images and the (non-zero) direction vectors, which in turn are determined by the directions of the ends using the balancing condition. The direction vectors are all primitive except for the edge with weight 2 in the image.

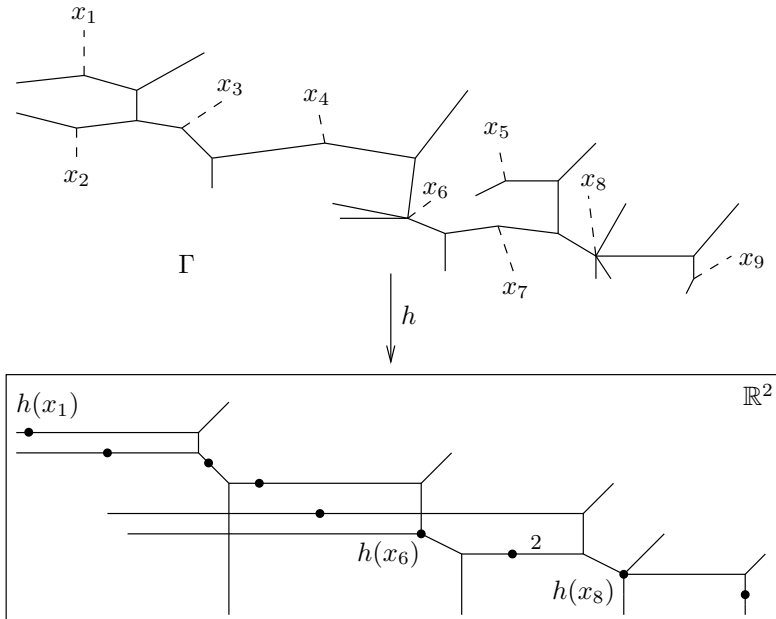

This curve contributes to $\tilde{N}_{5,\mathbf{k}}^{\text{trop}}$, where $\mathbf{k} = (7, 0, 1, 1)$, and where we chose $a = (0, 0, 0, 0, 0, 2, 0, 3, 0)$. Its multiplicity is $\frac{1}{2} \cdot \frac{1}{2} \cdot 2 \cdot 2 = 2$. The two factors of $\frac{1}{2}$ arise because two non-marked ends of the same direction are adjacent to the end vertex of x_6 and of x_8 . The two factors of 2 are the vertex multiplicities of the vertices of the edges of weight 2 (not adjacent to a contracted end). In the future, we want to avoid drawing the abstract curve together with its image. Therefore, we introduce the following shortcut for the picture above. When two edges of the abstract curve are mapped on top of each other in the image, we choose to draw them separately, but close to each other. In this way we can recover the parameterizing abstract curve uniquely (see [MR09] Lemma 9.9).

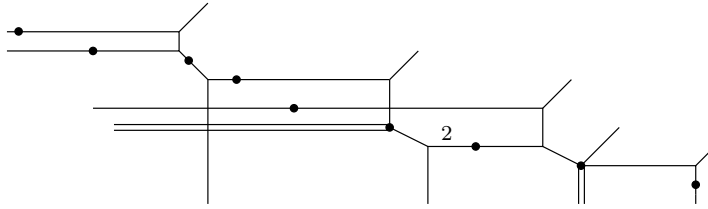

For every vector (a_1, \dots, a_n) containing i exactly \mathbf{k}_i times for all $i \geq 0$, the number $\tilde{N}_{d,\mathbf{k}}^{\text{trop}}$ equals the tropical intersection product $\prod_{i=1}^n \text{ev}_i^*(p_i) \psi_i^{\mathbf{k}_i}$ on the moduli space $\mathcal{M}_{0,n}(\mathbb{R}^2, d)$ of rational tropical n -marked curves in \mathbb{R}^2 of degree d by Remark 3.3 of [MR09], and is thus a *tropical descendant Gromov-Witten invariant*.

Later on, it will be convenient to allow arbitrary orderings of the Psi-powers. This leads to the following invariants.

Definition 3.5 ($N_{d,\mathbf{k}}^{\text{trop}}$). For $d \geq 1$ and \mathbf{k} a sequence of non-negative integers with $|\mathbf{k}| = 3d - 1$ we define the number $N_{d,\mathbf{k}}^{\text{trop}} := \sum_C \text{mult}(C)$ analogously to Definition 3.3, where now the sum is over all tropical curves C of degree d with non-marked left ends, such that for all i there are \mathbf{k}_i contracted ends whose adjacent vertex has valence $i + 3$.

Obviously, these numbers $N_{d,\mathbf{k}}^{\text{trop}}$ are related to the numbers $\tilde{N}_{d,\mathbf{k}}^{\text{trop}}$ of Definition 3.3 by $N_{d,\mathbf{k}}^{\text{trop}} = \frac{|\mathbf{k}|!}{\mathbf{k}!} \tilde{N}_{d,\mathbf{k}}^{\text{trop}}$.

Remark 3.6 (The equality $\tilde{N}_{d,\mathbf{k}}^{\text{trop}} = \tilde{N}_{d,\mathbf{k}}$). In [MR09] it was shown that tropical descendant Gromov-Witten invariants $\tilde{N}_{d,\mathbf{k}}^{\text{trop}}$ satisfy the WDVV relations, just as their classical counterparts $\tilde{N}_{d,\mathbf{k}}$ do. As the initial values coincide, we can conclude that $\tilde{N}_{d,\mathbf{k}}^{\text{trop}} = \tilde{N}_{d,\mathbf{k}}$ for all d and \mathbf{k} . There is no direct bijection of the corresponding curves known at this point. Since both pairs of numbers $\tilde{N}_{d,\mathbf{k}}^{\text{trop}}, N_{d,\mathbf{k}}^{\text{trop}}$ and $\tilde{N}_{d,\mathbf{k}}, N_{d,\mathbf{k}}$ differ by the same combinatorial factor, it follows of course that also $N_{d,\mathbf{k}}^{\text{trop}} = N_{d,\mathbf{k}}$. Both equalities also follow as the special case $\alpha = ()$, $\beta = (d)$ from our Caporasso-Harris formulas (see Remark 3.9).

3.2. Relative tropical descendant Gromov-Witten invariants. For two sequences α and β with $d = I(\alpha + \beta)$ let

$$\Delta(\alpha, \beta) = \left\{ \underbrace{(-1, 0), \dots, (-1, 0)}_{\alpha_1 + \beta_1}, \underbrace{(-2, 0), \dots, (-2, 0)}_{\alpha_2 + \beta_2}, \dots, \right. \\ \left. \underbrace{(0, -1), \dots, (0, -1)}_d, \underbrace{(1, 1), \dots, (1, 1)}_d \right\}$$

and consider parameterized n -marked tropical curves of degree $\Delta(\alpha, \beta)$ with $m - n = |\alpha + \beta|$ marked left ends (i.e. all the left ends are marked).

Definition 3.7 ($\tilde{N}_{d, \mathbf{k}}^{\text{trop}}(\alpha, \beta)$ and $N_{d, \mathbf{k}}^{\text{trop}}(\alpha, \beta)$). Let $d \geq 1$, and let \mathbf{k} be a sequence with $I(\alpha + \beta + \mathbf{k}) = 3d - 1 + |\beta| - |\mathbf{k}|$. Furthermore, for $n = |\mathbf{k}|$ fix a vector (a_1, \dots, a_n) containing each $i \geq 0$ exactly \mathbf{k}_i times. Let $p_1, \dots, p_n \in \mathbb{R}^2$ be points and $y_{n+1}, \dots, y_{n+|\alpha|}$ be y -coordinates in general position (analogously to Definitions 3.2 and 9.7 of [MR09]). For all $i = n + 1, \dots, n + |\alpha|$ choose a weight μ_i such that in total we have chosen each weight $k \geq 1$ exactly α_k times. In the same way, choose weights μ_i for $i = n + |\alpha| + 1, \dots, n + |\alpha + \beta|$ so that in total we have chosen each weight $k \geq 1$ exactly β_k times.

We then define

$$\tilde{N}_{d, \mathbf{k}}^{\text{trop}}(\alpha, \beta) := \sum_C \frac{1}{I^\alpha} \text{mult}(C),$$

where the sum is taken over all tropical curves $C = (\Gamma, x_1, \dots, x_m, h)$ with $m - n = |\alpha + \beta|$ marked left ends (i.e. all left ends are marked) of degree $\Delta(\alpha, \beta)$ satisfying

- $h(x_i) = p_i$ for all $i = 1, \dots, n$;
- the end x_i is adjacent to a vertex of valence $a_i + 3$ for all $i = 1, \dots, n$;
- for $i = n + 1, \dots, n + |\alpha|$, the y -coordinate of $h(x_i)$ equals y_i ;
- for $i = n + 1, \dots, n + |\alpha + \beta|$, the marked end x_i is of weight μ_i , i.e. we have $v(x_i) = (-\mu_i, 0)$.

Again, it follows from the general position of the points that all other vertices of Γ are 3-valent.

We also define the numbers $N_{d, \mathbf{k}}^{\text{trop}}(\alpha, \beta)$ analogously to Definition 3.5 as numbers of tropical curves passing through the given points, with \mathbf{k}_i contracted ends whose adjacent vertex has valence $i + 3$ for all i , with non-marked left ends of the specified weights, and satisfying that the prescribed set of y -coordinates for a given weight are the y -coordinates of left ends of this weight. The curves are counted with multiplicity $\frac{1}{I^\alpha} \text{mult}(C)$ as above. The numbers $N_{d, \mathbf{k}}^{\text{trop}}(\alpha, \beta)$ and $\tilde{N}_{d, \mathbf{k}}^{\text{trop}}(\alpha, \beta)$ are related by $N_{d, \mathbf{k}}^{\text{trop}}(\alpha, \beta) = \frac{1}{\beta!} \frac{|\mathbf{k}|}{\mathbf{k}!} \cdot \tilde{N}_{d, \mathbf{k}}^{\text{trop}}(\alpha, \beta)$.

Even though tropical descendant Gromov-Witten invariants are defined in [MR09] only in the non-relative case, a completely analogous argument shows that the numbers $\tilde{N}_{d,\mathbf{k}}^{\text{trop}}(\alpha, \beta)$ can also be interpreted as intersection products of evaluation pull-backs and Psi-classes on a suitable moduli space of tropical curves. Hence we can think of these numbers as *tropical relative descendant Gromov-Witten invariants*.

Example 3.8. The following curve contributes to $N_{5,(6,1,0,1)}^{\text{trop}}((1), (2, 1))$ with multiplicity $\frac{1}{2} \cdot 2 \cdot 2 = 2$. We have drawn a grey dot at the end of the up most left end in order to indicate that its y -coordinate is fixed.

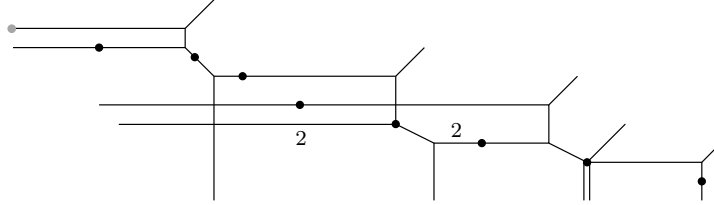

Remark 3.9 (The equality $\tilde{N}_{d,\mathbf{k}}^{\text{trop}}(\alpha, \beta) = \tilde{N}_{d,\mathbf{k}}(\alpha, \beta)$). There is no direct correspondence known between the numbers $\tilde{N}_{d,\mathbf{k}}^{\text{trop}}(\alpha, \beta)$ and $\tilde{N}_{d,\mathbf{k}}(\alpha, \beta)$. However, we prove in Theorem 4.16 that $N_{d,\mathbf{k}}^{\text{trop}}(\alpha, \beta) = N_{d,\mathbf{k}}^{\text{floor}}(\alpha, \beta)$, and we show in Theorem 4.18 and Corollary 2.9 that the numbers $N_{d,\mathbf{k}}^{\text{floor}}(\alpha, \beta)$ and $N_{d,\mathbf{k}}(\alpha, \beta)$ satisfy the same recursive relation. It follows that $N_{d,\mathbf{k}}^{\text{floor}}(\alpha, \beta) = N_{d,\mathbf{k}}(\alpha, \beta)$ and thus also that $N_{d,\mathbf{k}}^{\text{trop}}(\alpha, \beta) = N_{d,\mathbf{k}}(\alpha, \beta)$. Of course, the analogous statements hold for the numbers $\tilde{N}_{d,\mathbf{k}}^{\text{trop}}(\alpha, \beta)$ and $\tilde{N}_{d,\mathbf{k}}(\alpha, \beta)$ as well.

4. PSI-FLOOR DIAGRAMS

4.1. Absolute Psi-floor diagrams. Floor diagrams, introduced by Brugallé and Mikhalkin [BM07, BM09], are enriched directed graphs which, if counted correctly, enumerate plane curves satisfying certain point and tangency conditions. In the following, we generalize this definition to Psi-floor diagrams, and prove that they enumerate tropical plane curves satisfying point, tangency, and Psi-conditions. Let us begin with an example motivating in which sense floor diagrams extract the combinatorial essence of a tropical curve. Return to Example 3.4. There we have already chosen a horizontally stretched configuration (see Definition 3.1 of [FM10], they use vertically stretched). So we expect the tropical curve to decompose into floors, and the floors are connected by horizontal edges only. Let us point this out in the example:

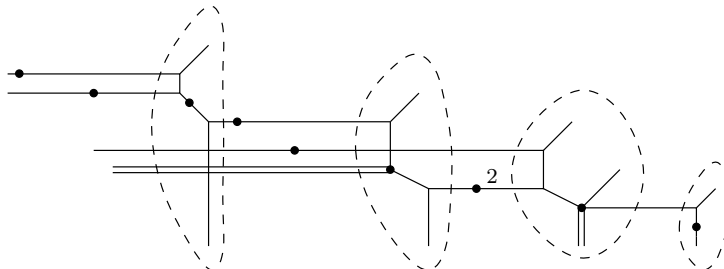

Each floor is fixed by one point, and the horizontal edges which are not adjacent to a Psi-point are also fixed by a point. We can already see that the presence of points satisfying Psi-conditions may lead to multiple floors — the second floor from the right is of degree 2, since it contains two ends of direction $(0, -1)$ resp. $(1, 1)$. The marked Psi-floor diagram of this curve can be found in step 3 of Definition 4.4.

In the original setting of floor diagrams [BM07, BM09, FM10] there are only single floors with one end of direction $(0, -1)$ and one of direction $(1, 1)$. There the idea is to shrink each floor to one vertex, and then first consider a weighted graph on the vertex set of all floors (a floor diagram). The weights of the edges correspond to the weights of the corresponding edges of the tropical curve. One obtains the “marking” of the floor diagram by adding in the ends and points on horizontal edges. Since any direction vector of an edge inside a floor has y -coordinate 1, a horizontal edge of weight i has to end at two vertices of multiplicity i each. Therefore, the multiplicity of a floor diagram equals the product over the squares of these weights.

Our setting is similar, but differs in a few features which we address now before giving the precise definition. We have seen already that multiple floors can occur. Consider a contracted end with Psi-condition ψ^a in a multiple floor of degree d' (i.e. d' ends of direction $(0, -1)$ resp. $(1, 1)$ belong to the floor). If we remove the contracted end from the abstract graph, we produce $a + 2$ connected components. Therefore, we must have $a + 2 \geq 2d'$ (the *string inequality*), since otherwise there would be a connected component which contains two ends, and thus a string (see Definition 3.5 of [GM08]), in contradiction to the general position of the points.

As explained above, a multiple floor of degree d' has d' ends of direction $(0, -1)$ and $(1, 1)$. Furthermore, it has some “incoming edges” of directions $(-m, 0)$ and some “outgoing edges” of directions $(m, 0)$ (for some $m \in \mathbb{Z}_{>0}$). Thus the balancing condition for the x -coordinate implies that the sum of the weights of the incoming edges equals the sum of the weights of the outgoing edges plus d' . This will be called the *divergence condition* of the floor diagram. Note however that we do not draw left ends of the tropical curve in the floor diagram. Therefore the divergence condition will be an inequality (that determines how many left ends are adjacent to a floor) and not an equality.

Psi-points do not need to lie on floors — they can also lie on horizontal edges, as the following picture shows.

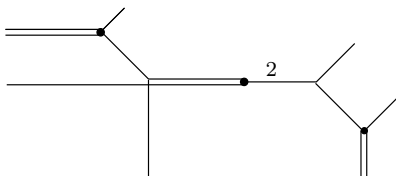

Since there may be bounded edges from other floors adjacent to such a Psi-point on a horizontal edge, we have to include these points in the underlying floor diagram. Therefore, we introduce degree-0 vertices corresponding to these points. As we do not draw ends in the floor diagram, the valence of such a degree zero vertex has to be

the correct one after adding the ends. The Psi-floor diagram (for details see below) of the tropical curve above is

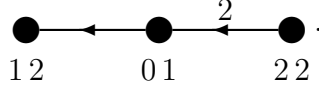

Here is the formal definition:

Definition 4.1. A (rational) *Psi-floor diagram* \mathcal{D} is a connected, directed graph (V, E) of genus 0 on a linearly ordered vertex set $(V, <)$ with edge weights $\omega(e) \in \mathbb{Z}_{>0}$ for all edges $e \in E$, together with pairs $(d_v, a_v) \in \mathbb{Z}_{\geq 0}^2$ for each vertex v in V (which we call the *degree* d_v and the *Psi-power* a_v of v), satisfying:

- (1) The edge directions preserve the vertex order, i.e. for every edge $v \rightarrow w$ we have $v < w$.
- (2) There are no edges between degree-0 vertices, i.e. if $v \rightarrow w$ is an edge then $d_v > 0$ or $d_w > 0$.
- (3) For each $v \in V$ at least one of the numbers d_v and a_v is positive.
- (4) For each $v \in V$ we have $a_v - 2(d_v - 1) \geq 0$ (string inequality).
- (5) (Divergence condition) For every vertex v we have

$$\operatorname{div}(v) := \sum_{\substack{\text{edges } e \\ v \xrightarrow{e} w}} \omega(e) - \sum_{\substack{\text{edges } e \\ w \xrightarrow{e} v}} \omega(e) \leq d_v.$$

This means that at every vertex of \mathcal{D} the total weight of the outgoing edges is larger by at most d_v than the total weight of the incoming edges.

- (6) If $d_v = 0$ for a vertex v , then $\operatorname{val}(v) = a_v + 2 + \operatorname{div}(v)$ (where $\operatorname{val}(v)$ is the valence of v).

We call $d(\mathcal{D}) = \sum_{v \in V} d_v$ the *degree* of a Psi-floor diagram \mathcal{D} . A *floor* of \mathcal{D} is a vertex of positive degree. The *type* of \mathcal{D} is $\mathbf{k}(\mathcal{D}) = (\mathbf{k}_0, \mathbf{k}_1, \dots)$, where \mathbf{k}_i is the number of vertices v of \mathcal{D} with $a_v = i$ for all $i \geq 1$, and \mathbf{k}_0 is the number of vertices v with $a_v = 0$ plus $3d - 1 - I\mathbf{k} - \#V$. The number $3d - 1 - I\mathbf{k} - \#V$ that we add to \mathbf{k}_0 equals the number of vertices of Psi-power 0 that we will add later and which makes the equality $I\mathbf{k} = 3d - 1 - |\mathbf{k}|$ hold. The *multiplicity* $\mu(\mathcal{D})$ of \mathcal{D} is given by

$$\mu(\mathcal{D}) := \prod_{\text{edges } e} \omega(e)^2 \prod_{\substack{v \xrightarrow{e} w \\ \text{s.t. } d_v=0 \\ \text{or } d_w=0}} \frac{1}{\omega(e)} \prod_{v: d_v=0} \frac{1}{|\operatorname{div}(v)|!}.$$

The first factor in the definition of multiplicity corresponds, as in the original definition of floor diagram, to vertices adjacent to edges of higher weight. If an edge of higher weight is adjacent to a contracted end however (e.g. at a vertex of degree 0), this vertex does not contribute and so we have to divide out by one factor of $\omega(e)$ again. The last factor contributes to the factor ν_C in Definition 3.2 of the multiplicity

of a tropical curve, which arises because ends of the same direction are adjacent to a vertex.

We draw Psi-floor diagrams using the convention that vertices in increasing order are arranged left to right, thereby adopting the convention of [FM10]. Note that in this paper we draw the corresponding tropical curves in the *opposite* direction. We write the pair (d_v, a_v) below each vertex v . Edge weights of 1 are omitted.

Example 4.2. An example of a Psi-floor diagram \mathcal{D} of degree $d = 5$, type $\mathbf{k} = (7, 0, 1, 1)$, divergences $1, 1, -1, -1$, and multiplicity $\mu(\mathcal{D}) = 4$ is drawn below.

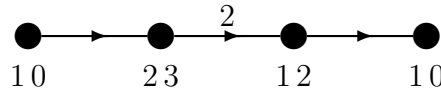

Given a Psi-floor diagram \mathcal{D} we define, for every floor v , the sets $I(v)$ and $O(v)$ by

$$I(v) := \{w \rightarrow v : d_w > 0\},$$

$$O(v) := \{v \rightarrow w : d_w > 0\} \cup \coprod \{v \xrightarrow{1} \circ\},$$

where the latter set is a disjoint union of the outgoing edges of \mathcal{D} at v augmented by $d_v - \text{div}(v)$ many *indistinguishable* edges of weight 1 directed away from v ending in distinct vertices \circ . These indistinguishable extra ends correspond to left ends of the tropical curve starting at this floor.

Example 4.2 (continued). We draw the sets $I(v)$ and $O(v)$ by augmenting the Psi-floor diagrams at the respective vertices. If, for example, v is the third black vertex from the left, then $O(v)$ consists of the edge between v and the fourth black vertex and the two edges of weight 1 connecting v with the two adjacent white vertices.

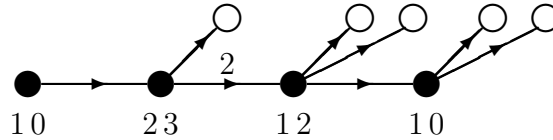

An *edge choice* is a collection $\mathcal{C}(\mathcal{D})$ of subsets $C(v) \subset I(v) \cup O(v)$, one for each floor v of \mathcal{D} , satisfying $|C(v)| = a_v - 2(d_v - 1)$, and such that $C(v) \cap C(w) = \emptyset$ for distinct floors v and w . If $d_v = 0$ for a vertex v we set $C(v) = \emptyset$. The *local multiplicity at v* of such a choice is

$$\mu_{v, C(v)} := \begin{cases} \frac{d_v^{i(v)}}{d_v!} \cdot \frac{d_v^{o(v)}}{d_v!} & \text{if } d_v > 0, \\ 1 & \text{if } d_v = 0. \end{cases}$$

where $i(v) = |I(v) \setminus C(v)|$ and $o(v) = |O(v) \setminus C(v)|$ are the number of non-chosen edges in $I(v)$ and $O(v)$, respectively.

The chosen edges will later correspond to the edges of the tropical curve that are directly adjacent to the Psi-point; the non-chosen edges to those belonging to the

floor but not directly adjacent to the Psi-point. We will see later in Lemma 4.9 and the proof of Theorem 4.8 that the local multiplicity at v of an edge choice takes the possibilities for the degree- d_v floor and the contribution to the multiplicity ν_C of Definition 3.2 into account.

The *multiplicity* $\mu(\mathcal{C})$ of the edge choice $\mathcal{C}(\mathcal{D})$ of the Psi-floor diagram \mathcal{D} is

$$\mu(\mathcal{C}) := \prod_{v \in V} \mu_{v, \mathcal{C}(v)} \frac{1}{|C(v) \cap \{v \rightarrow \circ\}|!} \prod_{e \in C(v)} \frac{1}{\omega(e)}.$$

As before, the multiplicity of an edge choice takes for each floor a combination of contributions to ν_C and possibilities for a floor into account, furthermore additional contributions to ν_C and factors of $\frac{1}{\omega(e)}$ that arise because an edge of weight $\omega(e)$ is adjacent to a contracted end.

Example 4.3. We picture an edge choice $\mathcal{C}(\mathcal{D})$ by thickening all edges in $C(v)$ at v , for all vertices v of \mathcal{D} . Below is an edge choice for the Psi-floor diagram of Example 4.2. Its multiplicity is $\mu(\mathcal{C}) = \frac{1}{2}$. Notice that $|C(v)| = a_v - 2(d_v - 1)$ for all v since none of the vertices has degree zero.

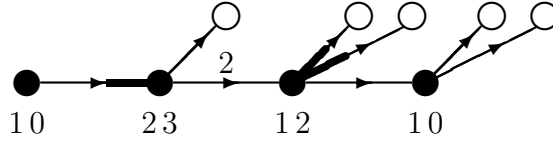

Definition 4.4. A *marking* of a Psi-floor diagram \mathcal{D} with an edge choice \mathcal{C} is defined by the following three-step process which we will illustrate in the case of Example 4.3.

Step 1: For each vertex v of \mathcal{D} create $d_v - \text{div}(v) - |C(v) \cap \{v \rightarrow \circ\}|$ many new vertices in \mathcal{D} and connect them to v with new edges directed away from v .

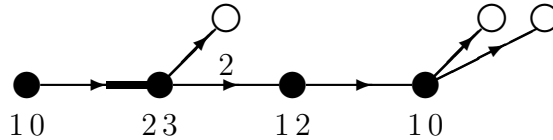

These correspond exactly to the non-chosen edges $v \rightarrow \circ$ above, i.e. to the left ends of the tropical curve that are not directly adjacent to the Psi-point in the floor (and therefore have to be fixed later by a point condition).

Step 2: Subdivide each non-chosen edge of the original Psi-floor diagram \mathcal{D} between floors into two directed edges by introducing a new vertex for each such edge. The new edges inherit their weights and orientations. Call the resulting graph $\tilde{\mathcal{D}}$.

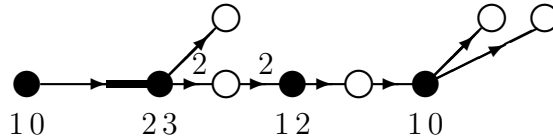

These extra vertices correspond to points on horizontal bounded edges with no Psi-condition.

Step 3: Order the vertices of $\tilde{\mathcal{D}}$ linearly, extending the order of the vertices of the original Psi-floor diagram \mathcal{D} , such that (as in \mathcal{D}) each edge is directed from a smaller vertex to a larger vertex.

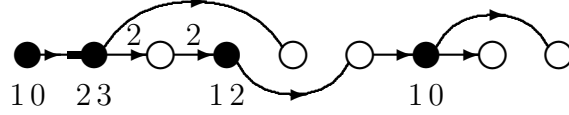

The extended graph $\tilde{\mathcal{D}}$ together with the linear order on its vertices is called a *marked Psi-floor diagram*, or a *marking* of the Psi-floor diagram \mathcal{D} .

We added $d_v - \text{div}(v)$ white end vertices for each $v \in V$ before picking the edge choice. It follows by induction that altogether we add d white end vertices. However, in step 1 of Definition 4.4 we really only add the non-chosen ones. In step 2 we subdivide each of the non-chosen edges. There are $\#V - 1$ edges, since the Psi-floor diagram is a rational graph. Thus, altogether we add $d + \#V - 1$ minus the number of chosen edges white vertices, i.e. $d + \#V - 1 - \sum_{v \in V} (a_v - 2(d_v - 1)) = 3d - 1 - I\mathbf{k} - \#V$. It follows that \mathbf{k}_0 equals the number of vertices v of the floor diagram with $a_v = 0$ plus the number of white vertices in the marking.

We want to count marked Psi-floor diagrams up to equivalence. Two such $\tilde{\mathcal{D}}_1, \tilde{\mathcal{D}}_2$ are *equivalent* if $\tilde{\mathcal{D}}_1$ can be obtained from $\tilde{\mathcal{D}}_2$ by permuting edges without changing their weights, i.e. if there exists an automorphism of weighted graphs which preserves the vertices of \mathcal{D} and maps $\tilde{\mathcal{D}}_1$ to $\tilde{\mathcal{D}}_2$.

The *number of markings* $\nu(\mathcal{D}, \mathcal{C})$ is the number of marked Psi-floor diagrams $\tilde{\mathcal{D}}$ up to equivalence. In the example, we have $\nu(\mathcal{D}, \mathcal{C}) = 7$: the white 1-valent vertex adjacent to the second black vertex (counted from the left) can be inserted in 2 ways between the second and third black vertex, in 2 ways between the third and fourth black vertex, and in 3 ways right of the fourth black vertex.

By specializing to the case $a_v = 0$ for all vertices v of \mathcal{D} we recover the definition of labeled floor diagrams and their markings of Fomin and Mikhalkin [FM10]. In this case all floors necessarily have degree $d_v = 1$ and no edges get chosen (so $C(v) = \emptyset$ for all vertices v).

Definition 4.5 ($N_{d,\mathbf{k}}^{\text{floor}}$ and $\tilde{N}_{d,\mathbf{k}}^{\text{floor}}$). Let $d \geq 1$ and \mathbf{k} be a sequence of non-negative integers with $I\mathbf{k} = 3d - 1 - |\mathbf{k}|$. Set

$$N_{d,\mathbf{k}}^{\text{floor}} := \sum_{\mathcal{D}} \mu(\mathcal{D}) \sum_{\mathcal{C}} \mu(\mathcal{C}) \nu(\mathcal{D}, \mathcal{C}),$$

where the first sum is over all Psi-floor diagrams of degree d and type \mathbf{k} , and the second sum is over all edge choices \mathcal{C} of \mathcal{D} . Correspondingly (see Definition 2.3), we set $\tilde{N}_{d,\mathbf{k}}^{\text{floor}} := \frac{\mathbf{k}!}{|\mathbf{k}|!} N_{d,\mathbf{k}}^{\text{floor}}$.

Remark 4.6. We can also define the numbers $\tilde{N}_{d,\mathbf{k}}^{\text{floor}}$ directly using Psi-floor diagrams by requiring that the Psi-powers of the vertices of the marked Psi-floor diagram (the Psi-powers of the white vertices that are not present in the underlying Psi-floor diagram have Psi-power 0) occur in a particular order, and by marking the white end vertices with numbers from 1 to d .

Example 4.7. As an example in degree $d = 4$ we compute the number

$$\tilde{N}_{4,(1,0,0,0,2)}^{\text{floor}} = \frac{1}{4}.$$

There are three markings of Psi-floor diagrams of degree 4 and type $(1, 0, 0, 0, 2)$ which have the Psi-powers in the order $(a_1, a_2, a_3) = (0, 4, 4)$. (Remember that we draw Psi-floor diagrams from left to right and therefore need to invert the order of the a_i .) Every other order of the a_i yields the same answer.

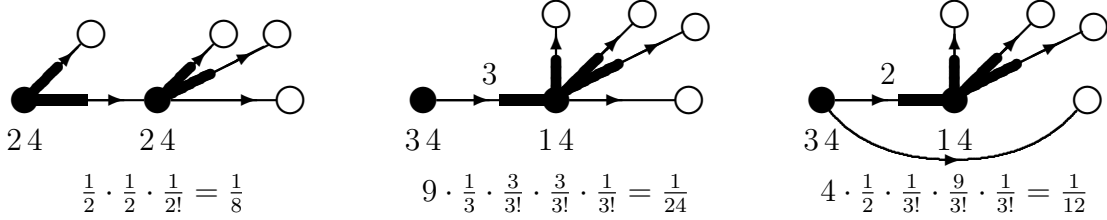

The contribution of the third diagram, for example, arises as follows: The underlying Psi-floor diagram has multiplicity 4. Choosing the weight-2 edge amounts to a factor of $\frac{1}{2}$. The degree-3 vertex has no non-chosen incoming edges and 2 non-chosen outgoing edges, hence the local multiplicity at this vertex is given by the next two factors. Lastly, as all 3 additional edges at the second vertex are chosen, we need to multiply by $\frac{1}{3!}$.

4.2. The equality $N_{d,\mathbf{k}}^{\text{floor}} = N_{d,\mathbf{k}}^{\text{trop}}$.

Theorem 4.8. *Let $d \geq 1$ and \mathbf{k} be a sequence of non-negative integers with $|\mathbf{k}| = 3d - 1 - |\mathbf{k}|$. Then $N_{d,\mathbf{k}}^{\text{floor}} = N_{d,\mathbf{k}}^{\text{trop}}$.*

For the proof of Theorem 4.8 we need the following lemma. For positive integers a and b , let $S(a, b)$ denote the *Stirling number of the second kind*, i.e. the number of ways of partitioning an a -element set into b non-empty parts.

Lemma 4.9 ([Sta97], (24d)). *For integers $e, f \geq 0$ it holds that*

$$\sum_{0 \leq g \leq f} \frac{S(e, g)}{(f - g)!} = \frac{f^e}{f!}.$$

Proof of Theorem 4.8. Pick a horizontally stretched configuration of $|\mathbf{k}|$ points (see Definition 3.1 of [FM10]). Our strategy is as follows: let T be the set of tropical curves of degree d satisfying the conditions, and let F be the set of marked floor diagrams of degree d and type \mathbf{k} . We will define a (surjective) map from T to F .

Let r be the number of inverse images of a given marked floor diagram $\tilde{\mathcal{D}}$ in F . We will show that each such inverse image is a tropical curve C of the same multiplicity $\text{mult}(C)$, and that $\text{mult}(C) \cdot r = \mu(\mathcal{D}) \cdot \mu(C)$, where \mathcal{D} denotes the underlying floor diagram for $\tilde{\mathcal{D}}$ and C denotes its choice of edges. Of course, this will then prove the lemma.

Consider a tropical curve in T ; we will now explain how to construct the corresponding marked floor diagram in F . As in Theorem 4.3 of [GM07] resp. Section 5 of [BM09] it follows that the tropical curve decomposes into floors in the sense that each connected component of Γ minus the horizontal edges (i.e. each floor) is fixed by exactly one point. (A floor can have higher degree here.) For each floor v let d_v denote its number of ends of direction $(0, -1)$ and a_v the power of Psi of the contracted end (i.e. the valence of the adjacent vertex minus 3). Shrink each floor to a vertex labeled with (d_v, a_v) . If there is a contracted end with a Psi-condition on a horizontal edge, also keep this as a vertex and set $d_v = 0$, and a_v the power of Psi. Let the edges of the floor diagram be given by the horizontal bounded edges of the tropical curve connecting the floors. We orient the edges towards the left ends of the curve, and reverse the picture (so the left ends are on the right, and edges are oriented to the right). Because of the general position of the points there cannot be two contracted ends mapped to a horizontal line — thus there cannot be any edges between vertices of degree 0. If $d_v = 0$ for a vertex we know that the corresponding contracted end has a Psi-condition, so then $a_v > 0$. Of course, if $a_v = 0$ then we must have $d_v > 0$. If there are horizontal ends adjacent to a contracted end on a floor resp. to a contracted end with higher Psi-condition on a horizontal edge, drop them. The other horizontal ends must be adjacent to a contracted end without a Psi-condition; keep the contracted end as a white end vertex. Also draw white vertices on horizontal edges for contracted ends without a Psi-condition on horizontal edges. Thicken the horizontal edges which are directly adjacent to a contracted end on a floor. A vertex of degree 0 in the floor diagram comes from a contracted end with a Psi-condition, say of power a_v , on a horizontal edge. Since the tropical curve is balanced, the sum of the weights of the incoming horizontal edges must equal the sum of the weights of the outgoing. The divergence condition for degree-0 vertices follows. The valence must be $a_v + 2$ (without counting the contracted end itself). We have dropped the ends adjacent to this vertex however, so we have $\text{val}(v) - \text{div}(v) = a_v + 2$. Now let v be a vertex of the floor diagram with $d_v > 0$. This vertex comes from a floor of the tropical curve which contains a contracted end with Psi-power a_v . If we remove the contracted end from Γ we produce $a_v + 2$ connected components. The floor contains $2d_v$ ends of direction $(0, -1)$ resp. $(1, 1)$. These ends must belong to different connected components since otherwise there would be a string (see Definition 3.5 of [GM08]) in contradiction to the general position of the points. It follows that $a_v + 2 \geq 2d_v$ (string inequality), and that $a_v + 2 - 2d_v$ horizontal edges are directly adjacent to the contracted end, and thus get chosen (including ends, which we drop). For a vertex of the floor diagram with $d_v > 0$, the balancing condition in the x -coordinate tells us that the divergence condition holds. It follows that we have produced a marked Psi-floor diagram in F for the curve in T .

Conversely, let now \tilde{D} be a marked floor diagram in F ; we will construct its inverse images in T . For each white vertex and for each vertex of degree 0 draw horizontal edges of the appropriate weight through the corresponding point p_i . For a vertex of degree $d_v > 0$ there are several possibilities how it can be completed to a floor of a tropical curve. We have seen already that — locally around such a floor of a tropical curve — removing the contracted end produces $a_v + 2$ connected components of which $a_v + 2 - 2d_v$ are horizontal edges and $2d_v$ are connected components containing one of the $2d_v$ ends of direction $(0, -1)$ resp. $(1, 1)$. There are $o(v)$ non-chosen outgoing horizontal edges connected to this floor. Their y -coordinates are fixed by other conditions. Thus they are distinguishable in the tropical curve, even if they are of the same weight. These edges must belong to the connected components containing the ends of direction $(1, 1)$. Assume that g of the d_v connected components containing the ends $(1, 1)$ also contain horizontal edges, whereas $d_v - g$ ends of direction $(1, 1)$ are directly adjacent to the contracted end. Thus we need to partition the set of $o(v)$ horizontal non-chosen edges into g non-empty parts, corresponding to the g connected components. For each such choice there is exactly one possibility to complete the picture to the upper part of a floor of a tropical curve since the y -coordinates of the horizontal edges are fixed by other points. This part of the tropical curve contributes a factor of $\frac{1}{(d_v - g)!}$ to the factor ν_C of the multiplicity of the tropical curve because of the $d_v - g$ ends of direction $(1, 1)$ which are directly adjacent to the contracted end. Thus we can sum up the possibilities with their contribution to ν_C as $\frac{S(o(v); g)}{(d_v - g)!}$ for each g . Summing over all g , we get $\frac{d_v^{o(v)}}{d_v!}$ by Lemma 4.9. This situation is illustrated in Example 4.10.

The analogous statement holds for the lower part of the floor of the tropical curve and the incoming horizontal edges. For any choice of g and a partition (both for the upper and the lower part of each floor) we can complete the picture uniquely to a tropical curve.

The multiplicity of the tropical curve is a product of factors contributing to ν_C and vertex multiplicities. We have taken care of the factors contributing to ν_C inside each floor already. There can still be left ends adjacent to the same vertex that contribute to ν_C . This happens either if left ends are adjacent to vertices of degree 0 in the floor diagram, or if they are directly adjacent to a contracted end inside a floor, i.e. chosen. For the first situation, we get a factor of $\frac{1}{\text{div}(v)!}$, for the second situation we get a factor of $\frac{1}{|C(v) \cap \{v \rightarrow o\}|!}$. Now let us consider the vertex multiplicities. We have seen already that each floor consists of components with one end of direction $(1, 1)$ resp. $(0, -1)$, and horizontal edges. The y -coordinate of any direction of an edge of such a component is therefore 1, and thus any vertex adjacent to a horizontal edge of weight $\omega(e)$ is of multiplicity $\omega(e)$. If a horizontal edge is adjacent to a contracted end however, this vertex does not contribute. If this contracted end comes from a white vertex however, there is another horizontal edge of the same weight adjacent to it. Thus, any horizontal edge in the floor diagram (without the marking) will contribute $\omega(e)^2$, unless it is adjacent to a vertex of degree 0, or unless it gets chosen later — in each of these cases it contributes only $\omega(e)$.

It follows that all inverse images of a marked floor diagram are tropical curves of the same multiplicity $\text{mult}(C)$, and if there are r inverse images we have $\text{mult}(C) \cdot r = \mu(\mathcal{D})\mu(C)$. \square

Example 4.10. The following picture illustrates how we can complete a vertex of a marked Psi-floor diagram to floors of a tropical curve. The local picture of $\tilde{\mathcal{D}}$ on the left shows 2 chosen incoming edges and 3 non-chosen outgoing edges adjacent to a floor of degree 2. The local multiplicity of this edge choice equals $\frac{2^0}{2!} \cdot \frac{2^3}{2!} = \frac{1}{2!} \cdot 4$. We would like to complete this picture to the floor of a tropical curve. The lower part is unique. The factor of $\frac{1}{2!}$ for the lower part takes care of the two down ends which are adjacent to the contracted end and thus lead to a contribution of $\frac{1}{2!}$ in the factor ν_C . For the upper part there are several possibilities. The middle column shows the $S(3, 2) = 3$ possibilities for $g = 2$, i.e. for the case where all components obtained after removing the contracted marked edge also contain horizontal edges. The right column shows the $S(3, 1) = 1$ possibility for $g = 1$, i.e. for the case where one of the ends of direction $(1, 1)$ is directly adjacent to the contracted end.

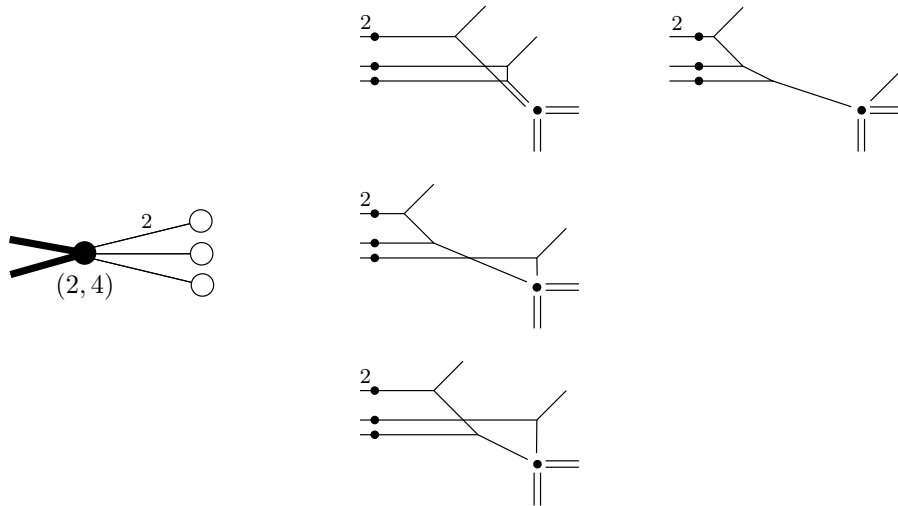

Remark 4.11. It follows immediately that also $\tilde{N}_{d,\mathbf{k}}^{\text{floor}} = \tilde{N}_{d,\mathbf{k}}^{\text{trop}}$ by taking the order of the contracted ends resp. vertices into account, both for the tropical curves and the floor diagrams.

4.3. Relative Psi-floor diagrams. We now define relative analogues of Psi-floor diagrams and their markings. Fix two sequences α and β . Our notation, which is more convenient for our purposes, differs from [FM10], where relative floor diagrams and their markings were defined relative to partitions $\lambda = (1^{\alpha_1} 2^{\alpha_2} \dots)$ and $\rho = (1^{\beta_1} 2^{\beta_2} \dots)$.

Let \mathcal{D} be a Psi-floor diagram of degree $d = I(\alpha + \beta)$. A pair $(\{\alpha(v)\}, \{\beta(v)\})$ of collections of sequences, where v runs over the vertices of \mathcal{D} , is called *compatible* with \mathcal{D} and (α, β) , if it satisfies:

- (1) The sums over each collection satisfy $\sum_{v \in V} \alpha(v) = \alpha$ and $\sum_{v \in V} \beta(v) = \beta$.

- (2) For all vertices v of \mathcal{D} it holds that $I(\alpha(v) + \beta(v)) = d_v - \text{div}(v)$.
(3) If $d_v = 0$ then we require in addition that $|\alpha(v)| = 0$ and $|\beta(v)| = a_v + 2 - \text{val}(v)$.

The sequences $\alpha(v)$ and $\beta(v)$ correspond to the left (fixed and non-fixed) ends adjacent to each floor. For a vertex of degree 0, all adjacent edges are directly adjacent to the contracted end, and thus there cannot be any fixed ends in this case.

In the non-relative case, i.e. when $\alpha = ()$ and $\beta = (d)$, it necessarily follows that $\alpha(v) = ()$ and $\beta(v) = (1 - \text{div}(v))$ for all vertices v of \mathcal{D} .

The *(relative) type* $\mathbf{k}(\mathcal{D}) = (\mathbf{k}_0, \mathbf{k}_1, \dots)$ of a Psi-floor diagram \mathcal{D} is defined as follows: for all $i \geq 1$ let \mathbf{k}_i be the number of vertices v of \mathcal{D} with $a_v = i$. Set \mathbf{k}_0 to be the number of vertices with $a_v = 0$ plus $2d + |\beta| - 1 - I\mathbf{k} - \#V$. The latter number equals the number of white vertices that we will add. This makes the equalities $|\mathbf{k}| = 2d + |\beta| - 1 - I\mathbf{k}$, resp. $I(\alpha + \beta + \mathbf{k}) = 3d - 1 + |\beta| - |\mathbf{k}|$ hold, where the latter is equivalent to the former since $d = I(\alpha + \beta)$.

The *relative multiplicity* of a Psi-floor diagram \mathcal{D} together with a collection of sequences $\{\beta(v)\}$ is

$$(4.1) \quad \mu^{\text{rel}}(\mathcal{D}) = \mu^{\text{rel}}(\mathcal{D}, \{\beta(v)\}) := I^\beta \cdot \prod_{\text{edges } e} \omega(e)^2 \cdot \prod_{\substack{v \xrightarrow{e} w \\ \text{s.t. } d_v=0 \\ \text{or } d_w=0}} \frac{1}{\omega(e)} \prod_{v: d_v=0} \frac{1}{\beta(v)!}.$$

For a collection of sequences $\{\beta(v)\}$ and a vertex v of \mathcal{D} we define the sets $I^{\text{rel}}(v)$ and $O^{\text{rel}}(v)$ by

$$I^{\text{rel}}(v) := \{w \rightarrow v : d_w > 0\},$$

$$O^{\text{rel}}(v) := \{v \rightarrow w : d_w > 0\} \cup \coprod \{v \xrightarrow{i} \circ\},$$

where the latter is a disjoint union of the outgoing edges of \mathcal{D} at v augmented by β_i^v *indistinguishable* edges of weight i for all $i \geq 1$, directed away from v and ending in distinct vertices \circ . These indistinguishable edges correspond to the non-fixed ends of the tropical curve adjacent to a floor, which a priori could be adjacent to the contracted end, and therefore can be chosen.

Example 4.12. Below we have indicated the sets $I^{\text{rel}}(v)$ and $O^{\text{rel}}(v)$ in the case of the Psi-floor diagram of Example 4.2 with $\alpha = (1)$, $\beta = (2, 1)$, and all $\alpha(v)$ and $\beta(v)$ being the zero sequence unless indicated otherwise. The relative multiplicity $\mu^{\text{rel}}(\mathcal{D}, \{\beta(v)\})$ is $4 \cdot 2 = 8$.

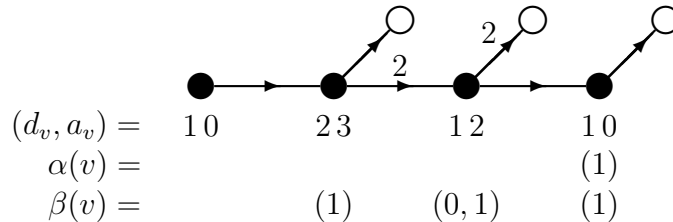

As before, an *edge choice* $\mathcal{C}(\mathcal{D})$ is given by a subset $C(v) \subset I^{\text{rel}}(v) \cup O^{\text{rel}}(v)$ for each floor v of \mathcal{D} such that $|C(v)| = a_v + 2 - 2d_v$ for all v , and $C(v) \cap C(w) = \emptyset$ for distinct floors v and w . If $d_v = 0$, we set $C(v) = \emptyset$. The *local multiplicity at v* of such a choice is

$$(4.2) \quad \mu_{v, C(v)}^{\text{rel}} := \begin{cases} \frac{d_v^{i(v)}}{d_v!} \cdot \frac{d_v^{o(v)}}{d_v!} & \text{if } d_v > 0, \\ 1 & \text{if } d_v = 0, \end{cases}$$

where, similarly to the absolute case, $i(v) = |I^{\text{rel}}(v) \setminus C(v)|$ is the number of non-chosen incoming edges and $o(v) = |O^{\text{rel}}(v) \setminus C(v)| + |\alpha(v)|$ is the number of non-chosen edges in $O^{\text{rel}}(v)$ together with some additional edges (corresponding to tangency conditions at fixed points, resp. to fixed left ends).

The *relative multiplicity* of the edge choice \mathcal{C} of the Psi-floor diagram \mathcal{D} together with a compatible pair of collections of sequences $(\{\alpha(v)\}, \{\beta(v)\})$ is

$$(4.3) \quad \mu^{\text{rel}}(\mathcal{C}) := \mu^{\text{rel}}(\mathcal{C}, \{\alpha(v)\}, \{\beta(v)\}) := \prod_{v \in V} \mu_{v, C(v)}^{\text{rel}} \prod_{v \in V} \prod_{e \in C(v)} \frac{1}{\omega(e)} \prod_{v \in V} \frac{1}{c(v)!},$$

where $c(v)$ is the sequence given by $c(v)_i := |C(v) \cap \{v \xrightarrow{i} \circ\}|$ for $i \geq 1$.

Example 4.12 (continued). An example of an edge choice for the above Psi-floor diagram together with collections $\{\alpha(v)\}$ and $\{\beta(v)\}$ is given below. As before, we indicate chosen edges by thickening edges at the vertices where they are chosen. Notice that $|C(v)| = a_v - 2(d_v - 1)$ at every vertex v since there are no vertices of degree 0. The relative multiplicity of the edge choice is $\mu^{\text{rel}}(\mathcal{C}) = \frac{1}{2}$.

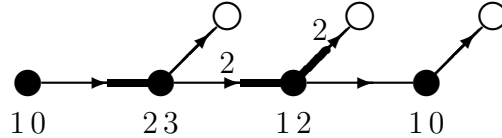

Definition 4.13. An (α, β) -*marking* of a Psi-floor diagram \mathcal{D} with a compatible choice of a pair of collections $(\{\alpha(v)\}, \{\beta(v)\})$ and an edge choice $\mathcal{C}(\mathcal{D})$ is defined by the following three-step process which we illustrate in the case of Example 4.12.

Step 1: For each vertex v of \mathcal{D} and every $i \geq 1$ create $\beta(v)_i - |C(v) \cap \{v \xrightarrow{i} \circ\}|$ new vertices (which we call β -vertices and illustrate as \circ), and connect them to v with new edges of weight i directed away from v . Similarly, create $\alpha(v)_i$ new vertices (which we call α -vertices and illustrate as \odot) and connect them to v with new edges of weight i directed away from v .

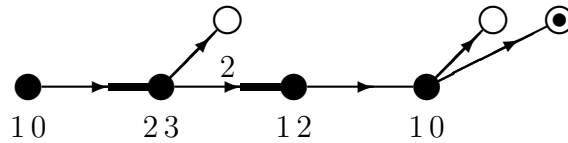

Step 2: Subdivide each non-chosen edge of the original Psi-floor diagram \mathcal{D} between floors into two edges by introducing a new vertex for each edge. The new edges inherit their weights and orientations. Call the resulting graph $\tilde{\mathcal{D}}$.

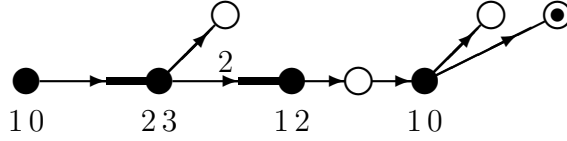

Step 3: Order the vertices of $\tilde{\mathcal{D}}$ linearly, extending the order of the vertices of the original Psi-floor diagram \mathcal{D} , such that (as in \mathcal{D}) each edge is directed from a smaller vertex to a larger vertex. Furthermore, we require that the α -vertices are largest among all vertices, and for every pair of α -vertices $v > w$ the weight of the v -adjacent edge is larger than or equal to the weight of the w -adjacent edge.

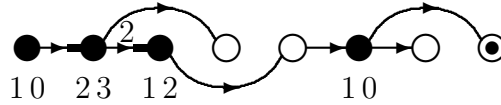

The (in this example unique) tropical curve mapping to the floor diagram above can be found in Example 3.8. As in the non-relative case, we call the extended graph $\tilde{\mathcal{D}}$ together with the linear order on its vertices an (α, β) -marked Psi-floor diagram, or an (α, β) -marking of the Psi-floor diagram \mathcal{D} .

In step 1 we added $|\beta|$ white vertices (of which we later remove the chosen ones), and in step 2 we subdivide the non-chosen ones of the $\#V - 1$ bounded edges. That is, altogether we added $|\beta| + \#V - 1 - \sum_{v \in V} (a_v - 2(d_v - 1)) = 2d - 1 + |\beta| - I\mathbf{k} - \#V$ white vertices.

As before, we need to count (α, β) -marked Psi-floor diagrams up to equivalence. Two (α, β) -marked Psi-floor diagrams $\tilde{\mathcal{D}}_1, \tilde{\mathcal{D}}_2$ are *equivalent* if $\tilde{\mathcal{D}}_1$ can be obtained from $\tilde{\mathcal{D}}_2$ by permuting edges without changing their weights, i.e. if there exists an automorphism of weighted graphs which preserves the vertices of \mathcal{D} and maps $\tilde{\mathcal{D}}_1$ to $\tilde{\mathcal{D}}_2$. The *number of markings* $\nu^{\text{rel}}(\mathcal{D}, \mathcal{C}) = \nu^{\text{rel}}(\mathcal{D}, \{\alpha(v)\}, \{\beta(v)\}, \mathcal{C})$ is the number of (α, β) -marked Psi-floor diagrams $\tilde{\mathcal{D}}$ up to equivalence. In our running example we have $\nu^{\text{rel}}(\mathcal{D}, \mathcal{C}) = 5$: the white vertex attached to the floor labeled (2, 3) can be placed in the linear order at any position to the right of this floor and to the left of the α -vertex.

By specializing to the case $a_v = 0$ for all vertices v of \mathcal{D} we recover the definition of (λ, ρ) -markings of floor diagrams of Fomin and Mikhalkin [FM10], for partitions $\lambda = (1^{\alpha_1} 2^{\alpha_2} \dots)$ and $\rho = (1^{\beta_1} 2^{\beta_2} \dots)$. As in the non-relative case, all floors necessarily have degree $d_v = 1$ and no edges get chosen.

Definition 4.14 ($N_{d, \mathbf{k}}^{\text{floor}}(\alpha, \beta)$ and $\tilde{N}_{d, \mathbf{k}}^{\text{floor}}(\alpha, \beta)$). Let $d \geq 1$ and α, β be two sequences with $I(\alpha + \beta) = d$. Furthermore, let \mathbf{k} be a sequence of non-negative integers with $I(\alpha + \beta + \mathbf{k}) = 3d - 1 + |\beta| - |\mathbf{k}|$. Set

$$N_{d, \mathbf{k}}^{\text{floor}}(\alpha, \beta) := \sum_{\mathcal{D}, \{\alpha(v)\}, \{\beta(v)\}} \mu^{\text{rel}}(\mathcal{D}) \sum_{\mathcal{C}} \mu^{\text{rel}}(\mathcal{C}) \nu^{\text{rel}}(\mathcal{D}, \mathcal{C}),$$

where the first sum is over all degree d Psi-floor diagrams of type \mathbf{k} and over all compatible pairs of collections $(\{\alpha(v)\}, \{\beta(v)\})$, and the second sum is over all edge choices \mathcal{C} of \mathcal{D} . Correspondingly (see Definition 2.5), we set $\tilde{N}_{d,\mathbf{k}}^{\text{floor}}(\alpha, \beta) := \beta! \cdot \frac{\mathbf{k}!}{|\mathbf{k}|!} N_{d,\mathbf{k}}^{\text{floor}}(\alpha, \beta)$.

Remark 4.15. As in Remark 4.6, we can also define the numbers $\tilde{N}_{d,\mathbf{k}}^{\text{floor}}(\alpha, \beta)$ directly using Psi-floor diagrams. Then we require that Psi-powers of the vertices of the marked Psi-floor diagram are in a fixed order, and we mark the white end vertices.

Theorem 4.16 (The equality $N_{d,\mathbf{k}}^{\text{floor}}(\alpha, \beta) = N_{d,\mathbf{k}}^{\text{trop}}(\alpha, \beta)$). *Let $d \geq 1$ and α, β be two sequences with $I(\alpha + \beta) = d$. Let \mathbf{k} be a sequence of non-negative integers satisfying $I(\alpha + \beta + \mathbf{k}) = 3d - 1 + |\beta| - |\mathbf{k}|$. Then $N_{d,\mathbf{k}}^{\text{floor}}(\alpha, \beta) = N_{d,\mathbf{k}}^{\text{trop}}(\alpha, \beta)$.*

The proof is analogous to the proof of Theorem 4.8.

Remark 4.17. Again, it follows immediately that the same equality holds for the numbers $\tilde{N}_{d,\mathbf{k}}^{\text{floor}}(\alpha, \beta) = \tilde{N}_{d,\mathbf{k}}^{\text{trop}}(\alpha, \beta)$ as well.

4.4. The Caporaso-Harris formula for floor diagrams. Now we use Psi-floor diagrams to obtain the Caporaso-Harris type recursion of Corollary 2.9 for the numbers $N_{d,\mathbf{k}}^{\text{floor}}(\alpha, \beta)$. As this recursion formula determines all the numbers it follows that $N_{d,\mathbf{k}}(\alpha, \beta) = N_{d,\mathbf{k}}^{\text{floor}}(\alpha, \beta)$. As we know by Theorem 4.16 that also $N_{d,\mathbf{k}}^{\text{floor}}(\alpha, \beta) = N_{d,\mathbf{k}}^{\text{trop}}(\alpha, \beta)$ holds, we thus have that

$$N_{d,\mathbf{k}}(\alpha, \beta) = N_{d,\mathbf{k}}^{\text{floor}}(\alpha, \beta) = N_{d,\mathbf{k}}^{\text{trop}}(\alpha, \beta)$$

for all $d, \mathbf{k}, \alpha, \beta$, as claimed in Remark 3.6. We use Notation 2.2 and the notation in equation (2.3) below.

Theorem 4.18 (Caporaso-Harris formula for Psi-floor diagrams). *The numbers $N_{d,\mathbf{k}}^{\text{floor}}(\alpha, \beta)$ satisfy the Caporaso-Harris recursion in Corollary 2.9.*

Proof. The basic strategy is to examine the possibilities for the largest vertex v' of an (α, β) -marking $\tilde{\mathcal{D}}$ of a Psi-floor diagram \mathcal{D} of degree d and type \mathbf{k} which is not an α -vertex (see step 1 in Definition 4.13 to recall the definition of α -vertices and β -vertices). The idea is to “cut off” the vertex v' and to interpret the contributions of the connected components of the remaining part again in terms of smaller floor diagrams.

The complement of v' and the v' -adjacent edges in $\tilde{\mathcal{D}}$ consists of markings $\tilde{\mathcal{D}}^1, \dots, \tilde{\mathcal{D}}^t$ of Psi-floor diagrams $\mathcal{D}^1, \dots, \mathcal{D}^t$ and some isolated α -vertices. For $1 \leq i \leq t$ define

- (1) d^i and \mathbf{k}^i to be the degree and the type of \mathcal{D}^i , respectively,
- (2) $\alpha^i = \sum \alpha(v)$ to be the sequence of multiplicities of edge weights between \mathcal{D}^i and the α -vertices of $\tilde{\mathcal{D}}$, where the sum is over all vertices v in the Psi-floor diagram \mathcal{D}^i ,
- (3) $\beta^i = \sum \beta(v)$, the respective count for the β -vertices of $\tilde{\mathcal{D}}$,

(4) m^i to be the weight of the edge between v' and \mathcal{D}^i .

Of course, $m^i = d^i - I(\alpha^i + \beta^i)$.

We will see later that all contributions from the components \mathcal{D}^i are of the form $N_{d^i, \mathbf{k}^i}^{\text{floor}}(\alpha^i + e_{m^i}, \beta^i)$ resp. $N_{d^i, \mathbf{k}^i}^{\text{floor}}(\alpha^i, \beta^i + e_{m^i})$. In these cases we necessarily have

$$(4.4) \quad I\alpha^i + m^i + I\beta^i + I\mathbf{k}^i = 3d^i - 1 + |\beta^i| - |\mathbf{k}^i|, \text{ resp.}$$

$$(4.5) \quad I\alpha^i + I\beta^i + m^i + I\mathbf{k}^i = 3d^i - 1 + |\beta^i| + 1 - |\mathbf{k}^i|.$$

Now consider the possibilities for the largest vertex v' . We will distinguish three cases.

Case 1: The vertex v' is not a vertex of the original diagram \mathcal{D} . Hence $\tilde{\mathcal{D}}$ looks locally around v' as in the following picture.

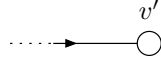

Then $t = 1$, $\alpha^1 = \alpha$ and $\beta^1 = \beta - e_{m^1}$. The (α^1, β^1) -markings of \mathcal{D} with v' maximal among all non- α -vertices are in canonical bijection with $(\alpha^1 + e_{m^1}, \beta^1)$ -markings of \mathcal{D} (by making v' an α -vertex and, for example, inserting it to the right of the other α -vertices adjacent to weight m^1 edges). This bijection is weight-preserving up to a factor m^1 , as edges of weight m^1 adjacent to β -vertices contribute a factor of m^1 whereas edges adjacent to α -vertices do not (see equation (4.1)). Thus, if v' is not a vertex of the original diagram we get a contribution of

$$\sum_{m^1: \beta_{m^1} > 0} m^1 \cdot N_{d^1, \mathbf{k}^1}^{\text{floor}}(\alpha^1 + e_{m^1}, \beta^1).$$

This contribution equals the summands with $d' = 0$ and $a = 0$ in the sum of Corollary 2.9: for $d' = 0$ the non-vanishing of $d'^{|\alpha'|+t-t'}$ implies that $|\alpha'| = 0$ and $t = t'$, and equation (4.4) (which can be rearranged to imply a valence and divergence condition on v' as we will show below) implies furthermore that $t' = 1$. This finishes case 1.

Now assume that v' is a vertex of the original diagram \mathcal{D} , and denote by d' and a the degree and Psi-power of v' , respectively. We need to count the number of ways in which markings of the Psi-floor diagrams $\mathcal{D}^1, \dots, \mathcal{D}^t$ can be combined to a marking of the Psi-floor diagram \mathcal{D} . We need to distinguish whether v' is a floor of \mathcal{D} (i.e. $d' > 0$) or not.

Case 2: v' is a vertex of \mathcal{D} , and $d' = 0$. Then we obtain the following local picture for $\tilde{\mathcal{D}}$.

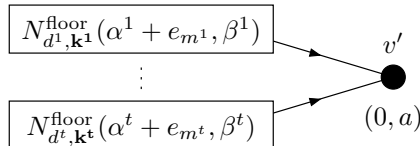

In this case none of the edges between v' and the Psi-floor diagrams \mathcal{D}^i can be chosen. Notice that $(\alpha^i, \beta^i + e_{m^i})$ -markings of \mathcal{D}^i with v' largest among all β -vertices (if we consider v' as a β -vertex of \mathcal{D}^i) are in canonical bijection with $(\alpha^i + e_{m^i}, \beta^i)$ -markings of \mathcal{D}^i . This bijection is weight-preserving up to a factor of m^i (see equation (4.1)).

To count the number of ways in which we can combine the markings of the pieces fix an $(\alpha^i + e_{m^i}, \beta^i)$ -marking of \mathcal{D}^i , one for each $1 \leq i \leq t$. Produce an (α, β) -marking of \mathcal{D} as follows: First, glue the markings by identifying all largest α -vertices in each of the marking of \mathcal{D}^i adjacent to an edge of weight m^i with each other (thereby obtaining the vertex v'). Then order the α -vertices of the markings by extending the partial order on the set of α -vertices given by the markings of the components to a linear order on all vertices. There are $\binom{\alpha}{\alpha^1, \dots, \alpha^t}$ ways to do this.

In a second step, we extend the partial order on the vertices that are less than v' to a linear order on all vertices less than v' . As v' is maximal among the non- α -vertices of the marking $\tilde{\mathcal{D}}$ it has $|\mathbf{k}| - 1$ vertices which are less than v' . Using the earlier bijection between (α^i, β^i) -markings of \mathcal{D}^i with v' largest among all β -vertices (if we consider v' as a β -vertex of \mathcal{D}^i) and $(\alpha^i + e_{m^i}, \beta^i)$ -markings of \mathcal{D}^i we see that there are $|\mathbf{k}^i|$ vertices in component i which are less than v' . Hence there are $\binom{|\mathbf{k}|-1}{|\mathbf{k}^1|, \dots, |\mathbf{k}^t|}$ linear extensions of the partial order that is induced by the linear orders of the components.

By equation (4.1) the product of the contributions from the t components differs from the contribution of the marking $\tilde{\mathcal{D}}$ by $\frac{1}{\beta(v')}$, but $\beta(v') = \beta - \sum \beta^i = \beta'$. Moreover, we overcount by $t!$ as we labeled the unlabeled components $1, \dots, t$. Altogether, we get a contribution of

$$\sum \frac{1}{t!} \frac{1}{\beta'} \binom{|\mathbf{k}| - 1}{|\mathbf{k}^1|, \dots, |\mathbf{k}^t|} \cdot \binom{\alpha}{\alpha^1, \dots, \alpha^t} \prod_{i=1}^t m^i \prod_{i=1}^t N_{d^i, \mathbf{k}^i}^{\text{floor}}(\alpha^i + e_{m^i}, \beta^i),$$

which equals the summands with $d' = 0$ but $a > 0$ in the recursion of Corollary 2.9. As before, equations (4.4) and (4.5) imply that v' has the correct divergence and valence (see below).

Case 3: v' is a vertex of \mathcal{D} , and $d' > 0$. In this case we obtain the following local picture for $\tilde{\mathcal{D}}$.

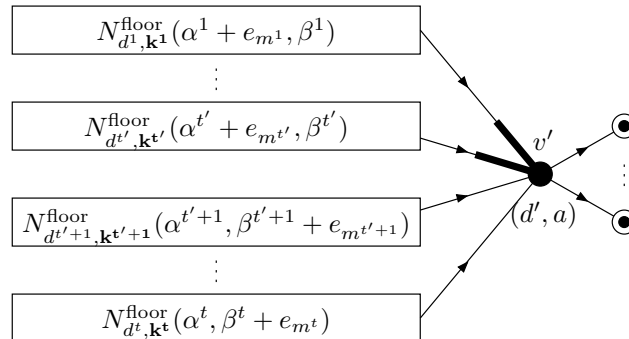

As then v' is largest among all non- α -vertices we have $C(v') \supset O(v')$. Define the Psi-floor diagrams $\mathcal{D}^1, \dots, \mathcal{D}^t$ and their markings $\tilde{\mathcal{D}}^1, \dots, \tilde{\mathcal{D}}^t$ as before, as well as d^i , \mathbf{k}^i , α^i , β^i and m^i , for $1 \leq i \leq t$. Without loss of generality we can assume that there is a number $t' \in \{0, \dots, t\}$ such that the edges between v' and $\tilde{\mathcal{D}}^i$ are chosen at v' for all $i \leq t'$, whereas for $i > t'$ they are not.

Now consider a component \mathcal{D}^i . We treat the cases $i \leq t'$ and $i > t'$ separately. If $i \leq t'$ then the $(\alpha^i, \beta^i + e_{m^i})$ -markings of \mathcal{D}^i with v' largest among all β -vertices (if we consider v' as a β -vertex of \mathcal{D}^i) are in canonical bijection with $(\alpha^i + e_{m^i}, \beta^i)$ -markings of \mathcal{D}^i by the same reasoning as for $d' = 0$. As we have seen, this bijection is weight-preserving up to a factor of m^i .

If $i > t'$ then a linear order (up to equivalence) on the vertices of $\tilde{\mathcal{D}}^i$ that can be extended to a marking of \mathcal{D} canonically determines an $(\alpha^i, \beta^i + e_{m^i})$ -marking of \mathcal{D}^i together with a distinguished β -vertex adjacent to an edge of weight m^i (namely the image of the edge of $\tilde{\mathcal{D}}^i$ which is closest to v' in $\tilde{\mathcal{D}}$). Conversely, given an $(\alpha^i, \beta^i + e_{m^i})$ -marking of \mathcal{D}^i together with a distinguished β -vertex adjacent to an edge of weight m^i , this canonically determines a linear order (up to equivalence) on the vertices of $\tilde{\mathcal{D}}^i$ that can be extended to a marking of \mathcal{D} . This $(\beta_{m^i}^i + 1)$ -to-1 map is weight-preserving up to a factor of m^i .

Again, to produce an (α, β) -marking of \mathcal{D} we need to extend the partial order on the set of α -vertices given by the markings of the components to a linear order on all α -vertices. There is no difference to the $d' = 0$ case, hence there are $\binom{\alpha^1, \dots, \alpha^t}{\alpha^1, \dots, \alpha^t}$ different extensions. As before, there are $\binom{|\mathbf{k}|-1}{\mathbf{k}^1, \dots, \mathbf{k}^t}$ ways to extend the partial order on the vertices that are smaller than v' to a linear order.

Also as before, by equation (4.1) the weight of a marking of \mathcal{D} differs from the product of the individual weights of the t components by contributions from the vertex v' . The local multiplicity at v' from equation (4.2) is $\frac{(d')^{t-t'}}{d'!} \frac{(d')^{|\alpha'|}}{d'!}$ as the number of non-chosen incoming vertices is $i(v') = |I(v') \setminus C(v')| = t - t'$ and

$$o(v') = |O(v') \setminus C(v')| + |\alpha(v')| = 0 + |\alpha'| = |\alpha'|$$

since $\alpha(v') = \alpha - \sum_i \alpha^i$. The second contribution from the vertex v' is $\frac{1}{\beta'^!}$ (see equation (4.3)), as $\beta' = \beta(v')$, $C(v') \supset O(v')$, and hence $c(v') = \beta(v')$, and these are the only contributions in which the markings of \mathcal{D} and the contributions from its components differ. Moreover, we overcount by $t'! \cdot (t-t)!$ as we labeled the unlabeled components $1, \dots, t'$ and $t'+1, \dots, t$.

Divergence and valence conditions for all cases: In all three cases, equations (4.4) and (4.5) imply that v' has the correct divergence and valence: summing up equations (4.4) for $1 \leq i \leq t'$ and (4.5) for $t'+1 \leq i \leq t$ yields

$$I\alpha - I\alpha' + I\beta - I\beta' + I\mathbf{k} - a + \sum m^i = 3d - 3d' - t' + |\beta| - |\beta'| - |\mathbf{k}| + 1.$$

Since $I(\alpha + \beta + \mathbf{k}) = 3d - 1 + |\beta| - |\mathbf{k}|$ we can conclude

$$(4.6) \quad -I\alpha' - I\beta' - a + \sum m^i = -3d' - t' - |\beta'| + 2.$$

Now replace m^i by $d^i - I(\alpha^i + \beta^i)$ and use that $d = I(\alpha + \beta)$ to obtain the valence condition at v' :

$$-a = -2d' - t' - |\beta'| + 2, \text{ resp. } 2d' + t' + |\beta'| = a + 2.$$

Together with equation (4.6) the valence condition implies the divergence condition at v' :

$$-I\alpha' - I\beta' + \sum m^i = -d', \text{ resp. } d' + \sum m^i = I(\alpha' + \beta').$$

Hence the contributions in the case when v' is a floor equal the summands with $d' > 0$ in the recursion of Corollary 2.9. This completes the proof. \square

Of course, one can also prove the recursion in Theorem 2.8 directly using Psi-floor diagrams. We then have to use the numbers $\tilde{N}_{d,\mathbf{k}}^{\text{floor}}(\alpha, \beta)$ of Remark 4.15, where we fix an order for the Psi-powers and mark the white end vertices.

REFERENCES

- [ABLdM08] Aubin Arroyo, Erwan Brugallé, and Lucia Lopez de Medrano, *Recursive formulas for Welschinger invariants*, Int. Math. Res. Not. IMRN (2011), no. 5, 1107–1134, arXiv: 0809.1541.
- [Blo10] Florian Block, *Computing node polynomials for plane curves*, Mathematical Research Letters **18** (2011), no. 4, 621–643, arXiv: 1006.0218.
- [BM07] Erwan Brugallé and Grigory Mikhalkin, *Enumeration of curves via floor diagrams*, C. R. Math. Acad. Sci. Paris **345** (2007), no. 6, 329–334, arXiv: 0706.0083.
- [BM09] Erwan Brugallé and Grigory Mikhalkin, *Floor decomposition of tropical curves: the planar case*, Proceedings of Gökova Geometry-Topology Conference 2008, 64–90, Gökova Geometry/Topology Conference (GGT), Gökova, 2009, arXiv: 0812.3354, 2009.
- [CH98] Lucia Caporaso and Joe Harris, *Counting plane curves of any genus*, Invent. Math. **131** (1998), no. 2, 345–392, arXiv: alg-geom/9608025.
- [FM10] Sergey Fomin and Grigory Mikhalkin, *Labeled floor diagrams for plane curves*, J. Eur. Math. Soc. **12** (2010), no. 6, 1453–1496, arXiv: 0906.3828.
- [FP97] William Fulton and Rahul Pandharipande, *Notes on stable maps and quantum cohomology*, Proc. Symp. Pure Math. **62** (1997), no. 2, 45–96, arXiv: alg-geom/9608011.
- [Gat02] Andreas Gathmann, *Absolute and relative Gromov-Witten invariants of very ample hypersurfaces*, Duke Math. J. **115** (2002), no. 2, 171–203, arXiv: math.AG/9908054.
- [GKM09] Andreas Gathmann, Michael Kerber, and Hannah Markwig, *Tropical fans and the moduli space of rational tropical curves*, Compos. Math. **145** (2009), no. 1, 173–195, arXiv: 0708.2268.
- [GM07] Andreas Gathmann and Hannah Markwig, *The Caporaso-Harris formula and plane relative Gromov-Witten invariants in tropical geometry*, Math. Ann. **338** (2007), 845–868, arXiv: math.AG/0504392.
- [GM08] ———, *Kontsevich’s formula and the WDVV equations in tropical geometry*, Adv. Math. **217** (2008), 537–560, arXiv: math.AG/0509628.
- [Get98] Ezra Getzler, *Topological recursion relations in genus 2*, Integrable systems and algebraic geometry (Kobe/Kyoto, 1997), World Sci. Publ., River Edge, NJ, 1998, arXiv: math.AG/9801003, pp. 73–106.
- [Gro09] Mark Gross, *Mirror Symmetry for \mathbb{P}^2 and tropical geometry*, Adv. Math. **224** (2010), no. 1, 169–245, arXiv: 0903.1378, 2009.
- [KM94] Maxim Kontsevich and Yuri Manin, *Gromov-Witten classes, quantum cohomology, and enumerative geometry*, Commun. Math. Phys. **164** (1994), no. 3, 525–562, arXiv: hep-th/9402147.

- [KM98] ———, *Relations between the correlators of the topological sigma-model coupled to gravity*, Commun. Math. Phys. **196** (1998), no. 2, 385–398, arXiv: alg-geom/9708024.
- [MR09] Hannah Markwig and Johannes Rau, *Tropical descendant Gromov-Witten invariants*, Manuscr. Math. **129** (2009), no. 3, 293–335, arXiv: 0809.1102.
- [Mik05] Grigory Mikhalkin, *Enumerative tropical geometry in \mathbb{R}^2* , J. Amer. Math. Soc. **18** (2005), 313–377, arXiv: math.AG/0312530.
- [Mik07] ———, *Moduli spaces of rational tropical curves*, Proceedings of Gökova Geometry-Topology Conference 2006, 39–51, Gökova Geometry/Topology Conference (GGT), Gökova, 2007, arXiv: 0704.0839, 2007.
- [Pan98] Rahul Pandharipande, *Rational curves on hypersurfaces (after A. Givental)*, Astérisque **252** (1998), 307–340, arXiv: math.AG/9806133.
- [Sta97] Richard Stanley, *Enumerative combinatorics. Vol. 1*, Cambridge Studies in Advanced Mathematics, vol. 49, Cambridge University Press, Cambridge, 1997.

FLORIAN BLOCK, DEPARTMENT OF MATHEMATICS, UNIVERSITY OF MICHIGAN, ANN ARBOR, MI 48109, USA

E-mail address: blockf@umich.edu

ANDREAS GATHMANN, FACHBEREICH MATHEMATIK, TECHNISCHE UNIVERSITÄT KAISERSLAUTERN, POSTFACH 3049, 67653 KAISERSLAUTERN, GERMANY

E-mail address: andreas@mathematik.uni-kl.de

HANNAH MARKWIG, UNIVERSITÄT DES SAARLANDES, FACHRICHTUNG MATHEMATIK, POSTFACH 151150, 66041 SAARBRÜCKEN, GERMANY

E-mail address: hannah@uni-math.gwdg.de